

The C-Class.

Saloon and Estate.



Mercedes-Benz

ngly rational: live for today and think of tomorrow. The beguiling form of the C-Class –
hen calm it down again: up to ten assistance systems, innovative telematics generation
elegant trims. A revolution of inner values. The C-Class Estate: as attractive as it is int
n the style. A defining generation: individual and spontaneous. Its purpose is to serve
which can protect you every step of the way. With the optional COMAND Online system
sis on freedom. Wilful disobedience: adrenaline for driving pleasure. True perfection:
re mature appearance. Wheels which sharpen the side profile. A fine chrome handle w
ails wherever you look. The C-Class Estate can be a lounge: with plenty of space, knee
ce, a payload of up to 540 kilograms and, as an option, the intelligent EASY-PACK load
board trimmed in wood or aluminium, for example, a steering wheel in nappa leather,
in every detail. **A class ahead.** The C-Class: it knows exactly where it comes from and
generation with its own rules. You can have it all. But with enjoyment comes responsi



Fascination.

Saloon. The C-Class goes its own way simply because it can. Confident and captivating in appearance with a powerful, masculine exterior. Seductive and appealing in character thanks to a fresh, stylish interior and intelligent details such as the optional PARKTRONIC, incl. Parking Guidance, and Becker® MAP PILOT systems. Thrilling in essence courtesy of options such as the Dynamic Handling package and 4MATIC. And that's not all: up to ten assistance systems available as optional extras, efficient engines and rich details with a piano-lacquer-look finish. The C-Class: a class ahead.

At a glance | from page 4 Insight | from page 30

Estate. The C-Class Estate: proof that practicality can go hand in hand with excitement. Exciting thanks to a provocative front section with distinctive features, dynamic headlamps and a powerful bumper. Reassuring courtesy of optionally available safety features and assistance systems normally the reserve of the luxury class, which always keep an eye on the driver and the road. Spacious on account of plenty of room for easy loading. Future-compatible by virtue of the outstanding efficiency provided by spirited engines with BlueEFFICIENCY. But, above all, an interior with an intelligently designed dashboard and visible luxury. The C-Class Estate races ahead: a class ahead.

At a glance | from page 18 Insight | from page 30

Featured models:
C 350 Saloon cover and from page 2 palladium silver metallic, AVANTGARDE line, AMG Sports package
C 250 CDI Saloon from page 4 cavansite blue metallic, ELEGANCE line
C 350 Estate cover and from page 18 palladium silver metallic, AVANTGARDE line, AMG Sports package
C 350 CDI Estate from page 20 diamond white metallic BRIGHT, ELEGANCE line

The illustrations may show accessories and optional extras which are not part of standard specification.

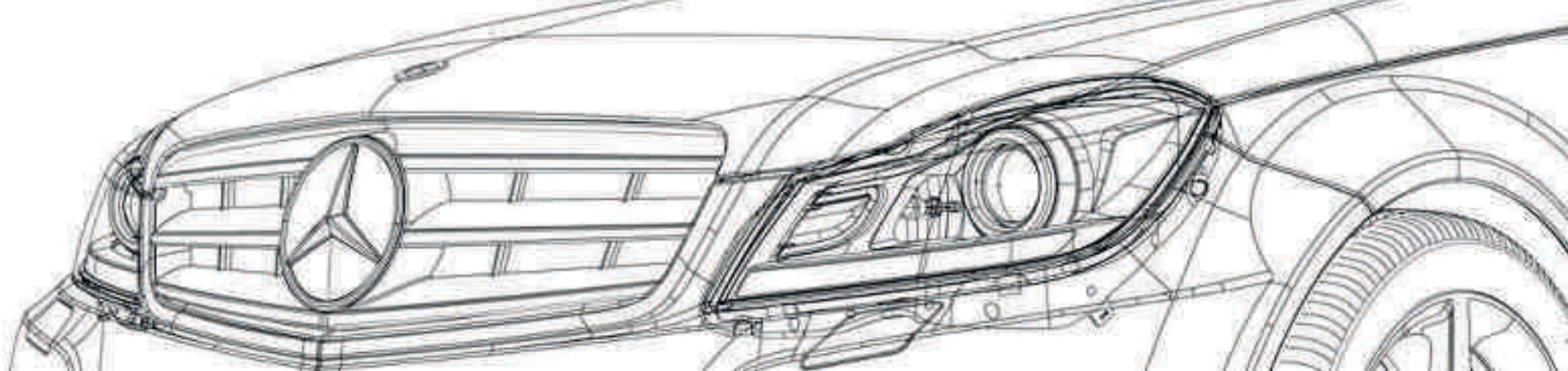

Facts.

Perfection in motion: Mercedes-Benz Intelligent Drive, BlueEFFICIENCY, diesel and petrol engines, transmissions, chassis and suspension.

Drive system & chassis | from page 36

All-round protection: the latest technologies in the integral safety concept for the “Safe driving”, “In the event of danger”, “In an accident” and “After an accident” phases.

Safety | from page 46

More luxury per mile: from multimedia and assistance systems to climate control and the estate’s versatile load compartment.

Comfort | from page 50

High-performance sport as standard: the equipment for the C 63 AMG and the options available from the AMG Performance Studio.

AMG | from page 62

All about the driver: design and equipment lines and packages, designo, standard equipment and optional extras, wheels and genuine accessories.

Equipment and appointments | from page 70

All-round service: Mercedes-Benz Financial Services, Mercedes-Benz mobility, Mercedes-Benz Museum, Test drive, Interactive Owner’s Manual and Mercedes-Benz Guides, Mobile internet, Mercedes-Benz service contracts, Accident repairs.

Services | from page 96

Impressive in every detail: dimensions, paintwork and technical data.

Facts & Colours | from page 98

They say nothing's perfect.
We beg to differ.





The C-Class knows exactly where it comes from and where it wants to go. Its aspiration is to lead, its path onwards and upwards. Incorporating outstanding technology, design and materials. A whole generation with its own rules.





Outclasses even the stiffest of opposition.

You can have it all. But with enjoyment comes responsibility. Agile on the one hand thanks to the AGILITY CONTROL suspension with selective damping and the optional Dynamic Handling package. Responsible-minded on the other thanks to BlueEFFICIENCY and direct injection. Uncompromisingly rational: live for today and think of tomorrow. → Page 36-41, 44, 45

A close-up, low-angle shot of the front of a dark-colored Mercedes-Benz C-Class car. The car is moving rapidly, as indicated by the blurred background and light trails. The front grille, featuring the Mercedes-Benz logo, and the license plate 'S C 2525' are clearly visible. The lighting is dramatic, with bright highlights on the car's body panels and a dark, moody background.

As impressive inside as it is outside.

The beguiling form of the C-Class – with its powerful and provocative front section – sets the heart racing. The comfort and convenience features then calm it down again: up to ten assistance systems, innovative telematics generation, optional climatized seats. With style wherever you look: a clearly laid-out dashboard, high-quality surfaces, elegant trims. A revolution of inner values.





Brilliant looks by day. Brilliant lighting by night.

The expressive lines of the C-Class catch the eye and invite you to discover the rest of the vehicle. But there are other, hidden, highlights, too: in the dark, the Intelligent Light System with its five intelligent lighting functions helps to make night driving safer. → Page 46





Never accept less. Except when it comes to emissions.

Save fuel, reduce emissions: be it the ECO start/stop function or the enhanced aerodynamics, BlueEFFICIENCY shows the way ahead. Without compromising on performance, dynamism or sportiness. Here less really does mean more. → Page 37





What lies beneath the pristine surface?
More pristine surfaces.







Just let your heart and mind
rule together.





The C-Class Estate: as attractive as it is intelligent. In a highly desirable form with all the functionality you could wish for. Here there is space to match the style. A defining generation: individual and spontaneous. → Page 58-61

Comfort has never been
more exciting.





Its purpose is to serve. Its true nature to seduce. The C-Class Estate achieves this with the optional Driving Assistance package Plus, which can protect you every step of the way. With the optional COMAND Online system, which makes every driver a decision maker. And with an impressive load capacity, which places great emphasis on freedom. Wilful disobedience: adrenaline for driving pleasure.

True perfection: nothing needs to be added or taken away. The C-Class Estate leads by example. With enhanced stature and a more mature appearance. Wheels which sharpen the side profile. A fine chrome handle which comes as standard. And LED tail lights which first draw you in and then cast their spell. Impressive details wherever you look.

**First impressions count.
And so do lasting ones.**





Size is also a matter of inner values.

The C-Class Estate can be a lounge: with plenty of space, kneeroom and shoulder room for up to five people. And it can be a load carrier: with up to 1500 litres of stowage space, a payload of up to 540 kilograms and, as an option, the intelligent EASY-PACK load compartment management system. Spaciousness is one of its trump cards. → Page 58-61





Even the inside can be a best side.

Always appropriate and in the proper style. The C-Class Estate has it all: a dashboard trimmed in wood or aluminium, for example, a steering wheel in nappa leather, and a high-resolution colour display in the instrument cluster. Indulging the senses: immaculate in every detail.









Inspiration from high above.

A classic, pale yellow manor house on the shore of Lake Como with a sign bearing the name “Villa Salazar”. What looks like an aristocratic retreat actually houses the Mercedes-Benz Advanced Design Studio – speciality interior design. Around 20 designers, modellers and engineers have been working here since 1998, leaving no stone unturned in their quest to make future Mercedes models as comfortable and enjoyable as possible for the driver and passengers. It is the perfect environment for our aesthetes: the Como – Milan – Turin

triangle is the hub of the Italian fashion and leather industry, where haute couture meets traditional craftsmanship. For the creative teams, this means exciting experiments with new forms, materials and finishes – and new ideas. And if they need inspiration, they can just look above and around them, as the villa’s ceilings and walls are painted with lavish, baroque frescos. The resulting designs – such as the interior of the C-Class – are timelessly elegant and comfortable, with every last detail perfectly conceived.

upholstery and trim. In the event of an accident. Metallic paints. Sound system. Petrol engine & suspension. Optional extras. Fuel consumption. Interior. In the event of danger. LED lights. ESP[®]. Dimensions. Standard equipment. Light. Multimedia systems. Drive system. Memory package. Transmissions. Surround sound system. Wheels. Interior. Safe driving. CO₂ emissions. Trim. Assistance systems. BlueEFFICIENCY. In an accident. Metallic paints. Petrol engine. Top speed. Chassis & suspension. Optional extras. Fuel consumption. Interior. Airbags. In the event of danger. Colours. Climate control. Seats. ESP[®]. Dimensions. Standard equipment. Light. Multimedia systems. Memory package. Transmissions. Surround sound system. Wheels. Interior. Acceleration. Interior. Services. Safety. Assistance systems. Upholstery and trim. In an accident. Metallic paints. Light-alloy wheels. Top speed. Optional extras. Chassis & suspension. Fuel consumption. Interior. Dimensions. **The facts.** Paintwork. Total displacement. Climate control. Seats. Dimensions. Appointments. Light-alloy wheels. Memory package. Transmissions. Wheels. Cylinder

36 **Mercedes-Benz Intelligent Drive**37 **BlueEFFICIENCY**38 **Diesel engines**

4-cylinder

6-cylinder

40 **Petrol engines**

4-cylinder

6-cylinder

42 **Transmissions**

6-speed manual transmission

7G-TRONIC PLUS

44 **Chassis & suspension**

4MATIC all-wheel drive

AGILITY CONTROL suspension

Sports suspension

Dynamic Handling package

46 **Integral safety concept**

ATTENTION ASSIST

Lane Tracking package

Intelligent Light System

Adaptive Highbeam Assist

Driving Assistance package Plus

PRE-SAFE® Brake and BAS PLUS

PRE-SAFE® system

NECK-PRO head restraints

Restraint systems

Mercedes-Benz emergency call system

Measures after an accident

50 **Multimedia systems**

COMAND Online

Audio 20 CD

Harman Kardon® Logic 7®

surround sound system

Becker® MAP PILOT

52 **Assistance systems**

Speed Limit Assist

Reversing camera

PARKTRONIC, incl. Parking Guidance

54 **Climate control**

THERMOTRONIC

THERMATIC

Rear climate control

56 **Seats**

Seats

Climatised seats

Memory package

58 **Space**

Load compartment

Load compartment cover

60 **Load compartment management**

EASY-PACK load-securing kit

Self-levelling suspension

EASY-PACK tailgate

62 **C 63 AMG exterior**

64 **C 63 AMG interior**

66 **C 63 AMG technology**

AMG 6.3-litre V8 engine

AMG sports suspension

AMG SPEEDSHIFT MCT

7-speed sports transmission

68 **AMG Performance Studio**

70 **Design and equipment lines,
incl. upholstery and trim**

Standard equipment

ELEGANCE line

AVANTGARDE line

82 **Equipment packages**

AMG Sports package

AMG Sports package Plus

designo

Style package

88 **Standard equipment**

90 **Optional extras**

92 **Wheels**

Standard wheels

Optional wheels

AMG wheels

Genuine accessory wheels

94 **Genuine accessories**

96 **Services**

Mercedes-Benz Financial Services

Mercedes-Benz mobility

Mercedes-Benz Museum

Test drive

Interactive Owner's Manual and

Mercedes-Benz Guides

Mobile internet

Mercedes-Benz service contracts

Accident repairs

98 **Dimensions**

98 | 101 **Paintwork**

99 **Technical data**

Mercedes-Benz Intelligent Drive – a new era in mobility.

Our engineers focus on the future every day, the aim being to implement innovative technology. This aspiration has resulted in developments that have had a lasting impact on automotive engineering. In other words, we are working to make sure that a Mercedes-Benz will always be ahead of its time.

We have developed one groundbreaking solution after another to get closer to realising our vision of safe and accident-free driving. Innovative technologies such as the anticipatory occupant protection system PRE-SAFE® and DISTRONIC PLUS proximity control first made it onto the road in a Mercedes-Benz, setting new standards in vehicle safety. This is because it was the first time that active and passive systems had been combined – for even better protection and driving comfort.

Mercedes-Benz Intelligent Drive takes things a stage further by intelligently combining the sensors from various safety and assistance systems. For us, it's a logical progression as the traffic situation has changed. There are more vehicles on the road, the driver's job is becoming more complex and the likelihood of distraction is increasing.

To give the driver even more assistance and deal with the specific situation effectively, we have revolutionised the car once more: a Mercedes-Benz is now able to “see” better in all dimensions. It has an even better view of the road and other road users, and it can react to what it sees.

We have developed a stereo camera system that is capable of seeing in three dimensions. Together with further sensors, this produces a 360° all-round view – a precise image of the surroundings. If the driving assistance and safety systems detect danger, they can respond within a fraction of a second to provide the driver with the right support for the situation in hand: by braking in dangerous situations, for example, or by masking out the portion of the main beam affecting oncoming traffic.

Pioneer of innovation – Mercedes-Benz Intelligent Drive once again underlines our ambition to lead and points the way ahead to accident-free and autonomous driving. The following pages include further information about our safety and comfort systems. They are available as standard equipment or optional extras for the C-Class, depending on the model specification; further details can be found on pages 46–49 and 52–53.

BlueEFFICIENCY – fast forward to tomorrow.

Mercedes-Benz brings the future of motoring to the road faster. With ever more efficient vehicles and a production process that wastes fewer and fewer resources. We call this all-encompassing approach BlueEFFICIENCY. By way of example, BlueTEC technology for the diesel engine reduces the nitrogen oxides in the exhaust gases by up to 90%, while the natural-gas drive NGT drastically reduces

emissions and fuel costs. Our hybrid models, featuring an intelligent combination of internal combustion engine and electric drive, can reduce fuel consumption significantly. What's more, electromobility is also moving into the fast lane with the SLS AMG Coupé Electric Drive. Meanwhile, technical and aerodynamic enhancements right down to the last detail make the BlueEFFICIENCY Editions

available in selected model series true champions of efficiency.

But every C-Class model already boasts a raft of BlueEFFICIENCY features – comprehensive vehicle optimisation measures that have been adapted specifically for this model series.



- 1 Radiator shutter.
- 2 Improved aerodynamics.
- 3 Weight optimisation.
- 4 Engine optimisation.
- 5 Intelligent energy management.
- 6 ECO start/stop function.
- 7 Driver information for energy-saving driving.
- 8 Tyres with optimised rolling resistance.
- 9 Energy-saving control of ancillary components
(power steering pump, fuel pump in the case of diesel engines).
- 10 Refrigerant compressor only activated when actually needed.

Diesel engines.

Clean, powerful and economical: the C-Class also features the latest Mercedes-Benz diesel technology. The powerful and quiet engines impress with their low emission and fuel-consumption figures.

4-cylinder in-line engines. The 4-cylinder diesel unit with a choice of four power outputs displays a high level of sophistication with torque aplenty and an instantaneous response, even at low revs. What's more, the diesel engines consume less fuel than their predecessors, have low emissions and are both quiet and powerful – attributes which are now also available with all-wheel drive in the

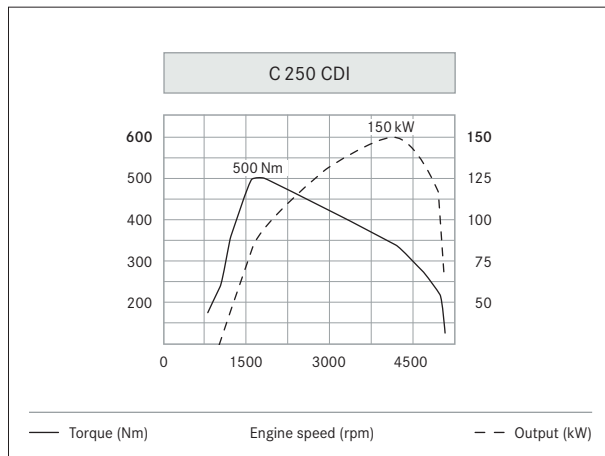

The C 250 CDI posts an excellent set of output, torque and fuel-consumption figures.

C 220 CDI 4MATIC. Fourth-generation common-rail diesel technology impresses by virtue of an injection pressure increased to up to 2000 bar, optimised combustion chambers and extremely precise injectors. Higher ignition pressure and the optimised turbocharger make for high torque in every engine speed range, while the requisite refinement comes courtesy of two Lanchester balancer shafts. Optimised alternator management ensures consistent use of the engine's coasting phases, thus allowing recuperation of kinetic energy. Meanwhile the radiator shutter reduces the aerodynamic drag when the engines require only moderate cooling.

The current engine generation delivers impressive output and high torque as well as reduced fuel consumption and CO₂ emissions. The reductions in consumption and emissions we have achieved with the C 220 CDI BlueEFFICIENCY Edition are particularly significant.

V6 engines. The C 350 CDI also places the emphasis on efficiency. In its latest guise, the updated and consumption-optimised V6 diesel engine develops 195 kW (265 hp), making it the most powerful diesel drive system with common-rail technology in the C-Class. Precise and fast injectors, a high injection pressure of up to 1600 bar, and an optimised turbocharger combine to produce an immense peak torque of 620 Nm – all of which adds up to effortlessly superior pulling power in all driving situations. In combination with 4MATIC all-wheel drive, the 6-cylinder diesel engine in the C-Class is also available as the C 300 CDI 4MATIC, developing 170 kW (231 hp) and peak torque of 540 Nm. For all their performance potential, both 6-cylinder diesel engines of course still meet the requirements of the Euro 5 emissions standard.

Further efficiency measures. The ECO start/stop function automatically turns off the engine when waiting at traffic lights or in a tailback and is available on almost all diesel models (with the exception of the C 300 CDI 4MATIC). The ECO display that is additionally available for many models provides feedback about the efficiency of the driving style, which can then be adapted accordingly in order to reduce fuel consumption.



The ECO display provides feedback about the efficiency of the driving style.



The 4-cylinder diesel engine is available with a choice of four outputs (C 220 CDI shown here).

Petrol engines.

Mercedes-Benz offers a wide range of environmentally compatible engines. Intelligent technologies reduce fuel consumption, while CO₂ emissions are lower than ever for a Mercedes-Benz C-Class.

4-cylinder in-line engines. The 4-cylinder unit of the C 180, with a displacement of 1.6 litres, direct petrol injection, variable valve timing and a turbocharger offers outstanding torque and power, not to mention appropriately low fuel consumption and emissions. This is made possible by direct injection, at a pressure of up to 200 bar, which ensures optimum preparation of the fuel-air mixture. The engine management system optimises the valve timing of the piezo injectors with multi-hole valves. The air flow paths have also been designed to offer as little resistance as possible and the weight of the engine has been reduced through measures such as the use of aluminium for the crankcase and the adoption of a hollow-cast crankshaft.

What's more, BlueEFFICIENCY measures and other enhancements reduce fuel consumption. The range of optimisation measures includes on-demand control of engine ancillaries or, for example, the electromechanical steering of the C 180. This only requires energy during the actual process of steering – without any compromises in terms of steering comfort.

The 4-cylinder petrol engines come with a choice of three power outputs:

- C 180 developing 115 kW (156 hp) and a peak torque of 250 Nm
- C 200 developing 135 kW (184 hp) and a peak torque of 270 Nm
- C 250 developing 150 kW (204 hp) and a peak torque of 310 Nm

All engines are exceptionally quiet and meet strict fuel consumption and emission requirements (Euro 5). The C 180 already complies with the Euro 6 emissions standard which comes into force in 2014.

V6 engine. Up to 31% lower fuel consumption than the predecessor model and correspondingly lower CO₂ emissions yet enhanced dynamics – a neat way of summing up the C 350. These advantages are primarily down to the direct petrol injection from Mercedes-Benz, which operates using

spray-guided combustion and high-pressure piezo injectors. Maximum output is 225 kW (306 hp), while the peak torque of 370 Nm is available between 3500 and 5250 rpm. In addition to the modified combustion process, further factors which help reduce fuel consumption include an innovative air and exhaust system, controlled ancillaries, intelligent alternator management and systematic use of lightweight design. Outstanding refinement is another of the V6 engine's hallmarks. The C 350 Saloon is also available with 4MATIC all-wheel drive.

Further efficiency measures. All petrol models are equipped as standard with the ECO start/stop function which automatically turns off the engine when waiting at traffic lights or in a tailback. The ECO display available for many models provides feedback about the efficiency of the driving style which can then be adapted accordingly to reduce fuel consumption.



The 4-cylinder engines feature direct petrol injection, variable valve timing and a turbocharger (C 250 shown here).

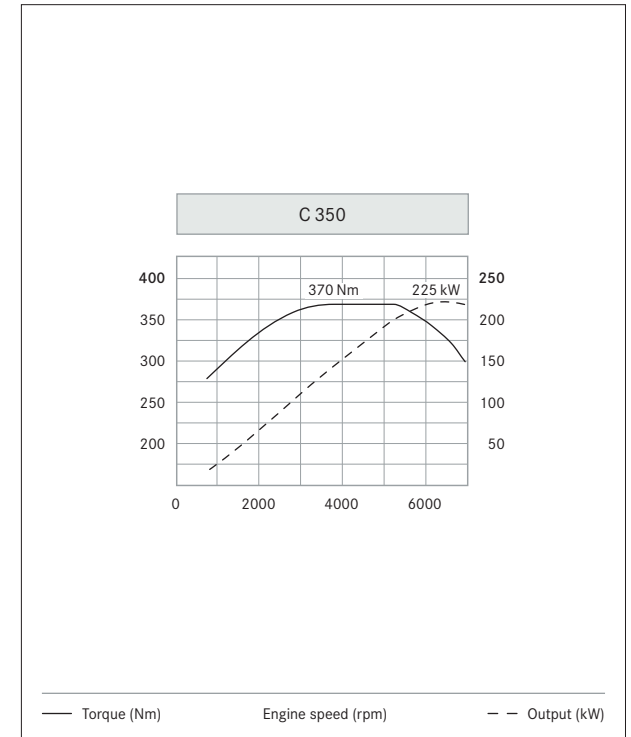

The C 350 offers the ideal combination of harmonious power delivery, driving enjoyment and energy efficiency.

Transmissions.

Whether it be a manual gearshift or an automatic, an economical or a sporty driving style – the transmissions for the C-Class have been optimised in line with the model in which they are installed. Plus they are intuitive and ergonomic to use.

6-speed manual transmission. The 4-cylinder engines (with the exception of the C 250 and models with 4MATIC all-wheel drive) are paired with a 6-speed manual transmission – with the ECO start/stop function as standard – which offers impressively short, precise shift travel and whose gear spacing is optimally matched to the rear axle ratio. A display on the instrument cluster indicates recommended gear changes to further encourage a highly economical driving style.

7G-TRONIC PLUS. The 7G-TRONIC PLUS is fitted as standard in all 6-cylinder models, in the all-wheel drive variants and in the C 250. This automatic transmission makes use of a torque converter to ensure dynamic response, longevity, reduced noise levels and significantly lower fuel consumption.

The latter is also thanks to the inclusion as standard of the ECO start/stop function (except in the C 300 CDI

4MATIC), which turns off the engine temporarily when the car is stopped at traffic lights or in a tailback. Furthermore, the seven forward gears in the 7G-TRONIC PLUS ensure an ideally adapted engine speed at all times, short shift times and smooth shifts. Driving enjoyment is likewise enhanced: the car delivers even better acceleration and provides even more pulling power. And when changing down, gears can be skipped for fast in-gear acceleration.

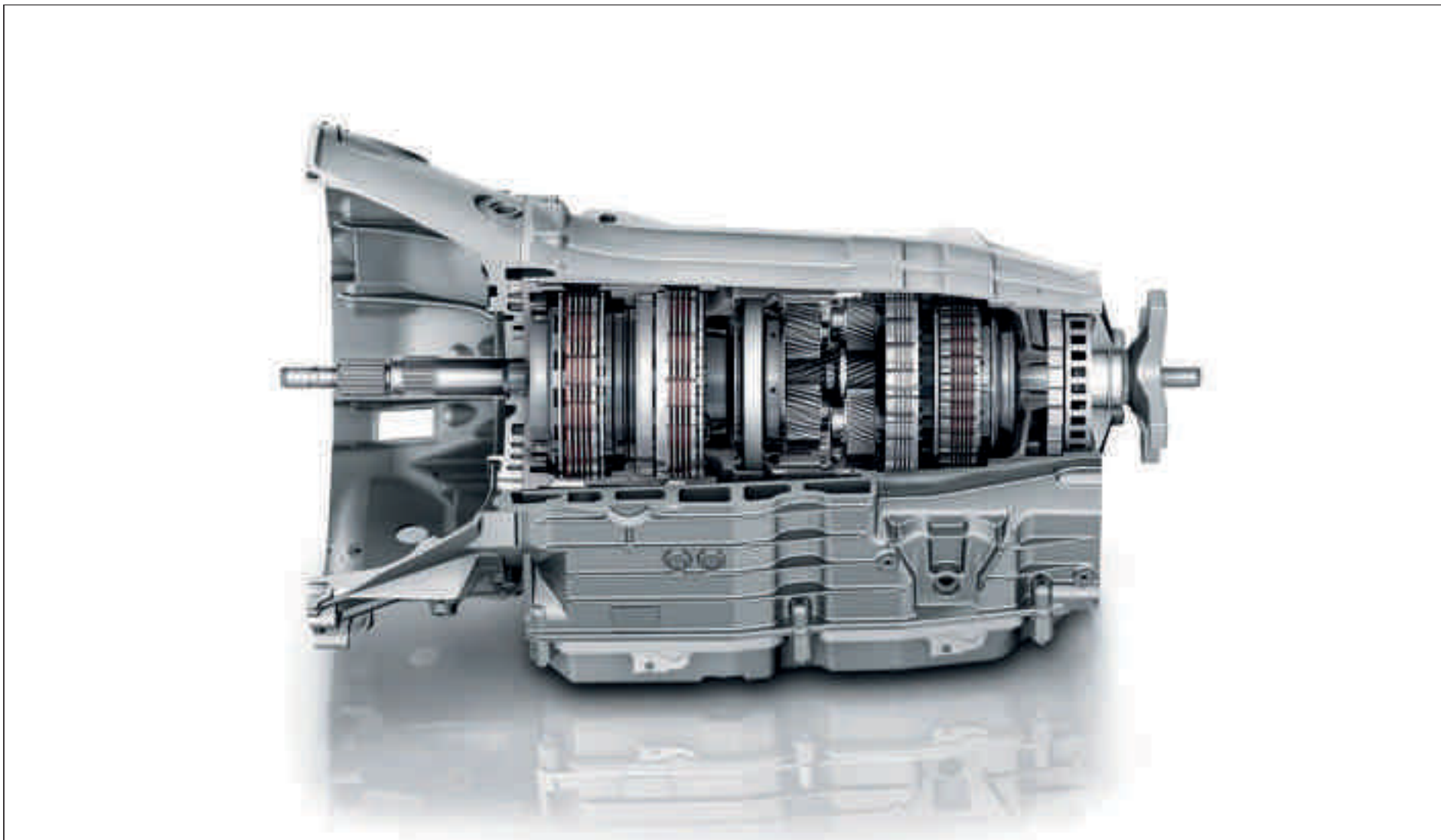

7G-TRONIC PLUS: one of over 18 million automatic transmissions produced in a period spanning more than 50 years.

Chassis & suspension.

4MATIC permanent all-wheel drive provides impressive traction as well as enhanced driving stability. The AGILITY CONTROL suspension with selective damping system really comes into its own on the road, offering a high level of comfort as well as impressive agility.

4MATIC all-wheel drive (option). As 4MATIC is always active, it responds almost instantaneously in poor weather conditions such as rain, black ice or snow. 4MATIC is assisted by the Electronic Stability Program ESP^{®1} and the electronic traction system 4ETS. The latter enables controlled braking of spinning wheels and, as a consequence, increases the drive torque at the wheels offering good traction, improving

the amount of power to be planted on the road when moving off and when accelerating, especially on poor road surfaces. 4MATIC makes conventional differential locks superfluous: the automatic braking pulses make it easier to move off on slippery ground as well as enhancing stability during critical manoeuvres. A further advantage of the system is the fact that it is hardly any heavier than the rear-wheel

drive version on account of the compact design, intelligent choice of materials and high level of efficiency. 4MATIC is only available in conjunction with the 7G-TRONIC PLUS automatic transmission.

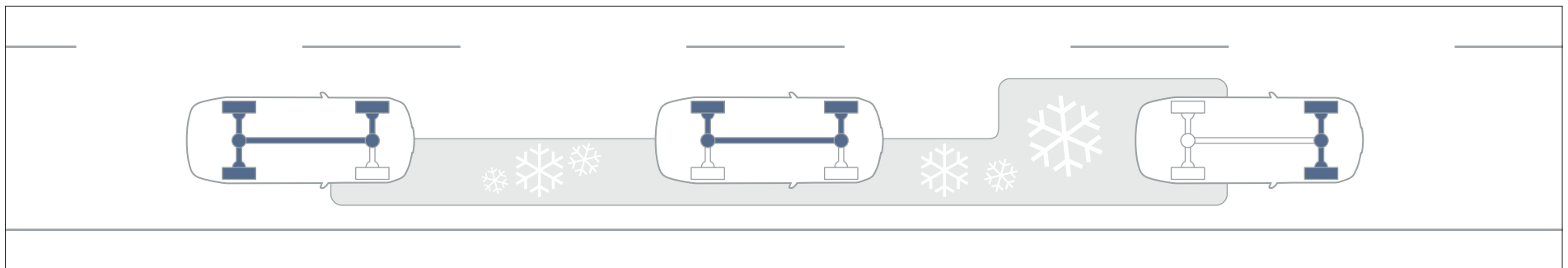

The electronic traction system 4ETS automatically sends the drive torque to the wheels offering sufficient traction.

¹ Integral component of Mercedes-Benz Intelligent Drive. More on page 36.

AGILITY CONTROL suspension (standard). The AGILITY CONTROL suspension with selective damping system combines agility and ride comfort, as the shock absorbers adjust automatically to suit the current driving situation. The enhanced damping and vehicle stability are especially beneficial on poor road surfaces.

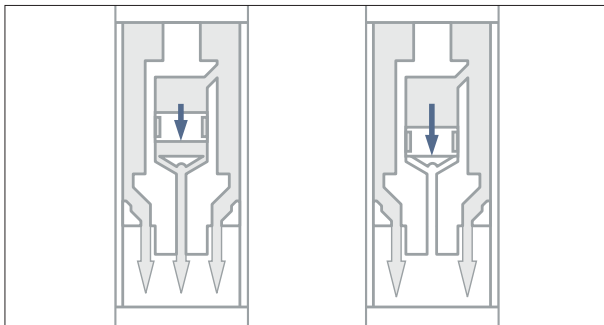

Agility with a high level of comfort – the AGILITY CONTROL suspension adjusts the shock absorbers automatically.

Sports suspension (option, standard in conjunction with AMG Sports package and AMG Sports package Plus). The AGILITY CONTROL sports suspension with firmer settings and a body lowered by 15 mm is available as an optional extra. The springs and dampers are stiffer than those used by the standard-fit AGILITY CONTROL suspension, thus reducing body roll and enhancing driving stability. The speed sensitive sports steering's more direct ratio complements the suspension by transferring the steering movements to the road even more spontaneously.

Dynamic Handling package (option). Enhanced driving dynamics and driving pleasure are available at the touch of a button thanks to this package with its special sports mode. Pressing the “S” button causes the shift program of the 7G-TRONIC PLUS automatic transmission to adopt a more aggressively responsive mode. This results in a noticeably more direct engine response which delivers optimal acceleration performance and, therefore, enhanced longitudinal dynamics. Another press of a button and the Adaptive Damping System sets up a noticeably firmer suspension response for significantly increased lateral dynamics during fast cornering. This dual approach allows the lateral and longitudinal dynamics to be adjusted separately. The speed-sensitive sports steering conveys a direct, sporty steering feel in both driving modes.

Integral safety concept.

The vision of accident-free driving impels us. With our integral safety concept we are coming closer to achieving this goal – this is a holistic approach which can increase safety in every situation.

As the inventor of the car we feel that we have a special responsibility for road safety. This is why we are the first car manufacturer to have developed an integral safety concept which seamlessly blends measures to enhance active and passive safety. The holistic approach is subdivided into four phases and offers safety solutions for every situation. It includes systems for safe driving which help to avoid risks by warning you and coming to your aid in good time. Our unique PRE-SAFE® system¹ kicks in in the event of danger and activates preventive measures for occupant protection. If a collision should still occur in spite of all the preventive measures, further technologies ensure protection as needed. We have also borne in mind the time immediately following an accident and developed solutions which can help prevent worse and support the rapid provision of assistance.

A selection of these technologies for the “Safe driving”, “In the event of danger”, “In an accident” and “After an accident” phases is presented on the pages which follow.

Safe driving: ATTENTION ASSIST¹ (included with the optional luxury multifunction steering wheel). This drowsiness detection system can be especially useful on long trips. Between 80 and 180 km/h, ATTENTION ASSIST warns the driver as soon as it detects typical signs of drowsiness or inattention. All thanks to sensors that can analyse driving behaviour and detect any changes in it.

Safe driving: Lane Tracking package¹ (option). Lane Keeping Assist detects the markings on the road. If the car leaves its lane unintentionally, the system can warn the driver by making the steering wheel vibrate gently. Blind Spot Assist uses two radar sensors to monitor the poorly visible area directly alongside and behind the car – the blind spot. If the system detects the danger of an impending collision with a vehicle when changing lanes, it warns the driver by a signal in the exterior mirror if the car is travelling at 30 km/h or more. Lane Keeping Assist and Blind Spot Assist are also available separately as individual options.

Safe driving: Intelligent Light System¹ (option). The system has five settings: the country mode illuminates the edge of the road, the motorway mode the entire width of the road. The extended fog lamp function improves visibility in bad weather, whilst the active light function and the cornering light function follow the driver’s steering angle.

Safe driving: Adaptive Highbeam Assist¹ (option). This feature continuously adjusts the range of the dipped headlamps to the current traffic situation. If no other road

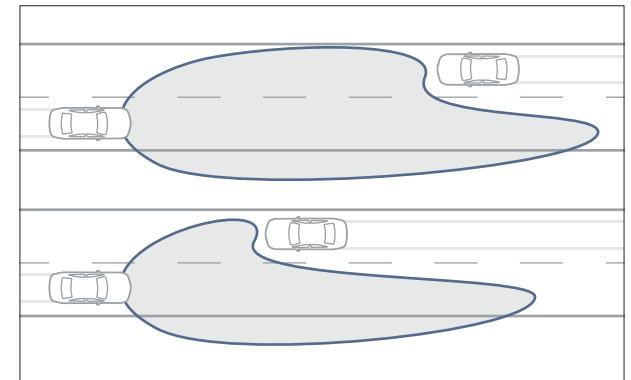

Adaptive Highbeam Assist detects other road users with their lights on and ensures the greatest possible range of vision.

¹ Integral component of Mercedes-Benz Intelligent Drive. More on page 36.

users are detected, the main beam is activated. The beam is dipped automatically as soon as oncoming vehicles with lights on are detected.

Safe driving: Driving Assistance package Plus¹ (option).

The package comprises a series of separate intelligent technologies: Active Lane Keeping Assist¹ vibrates the steering wheel gently to warn a driver who unintentionally leaves the recognised, marked lane. If the driver fails to react, a lane-correcting brake actuation can occur. Active Blind

Spot Assist¹ ensures increased safety when changing lanes.

Two radar sensors observe the area which the driver cannot see well in the exterior mirrors – the “blind spot”. If the driver activates the indicator and the assistance system detects a vehicle in the danger zone, a warning triangle flashes in the exterior mirror and an acoustic alert is sounded. If the driver still starts to turn the steering wheel, targeted brake actuation on one side of the vehicle warns against the possible danger and can thus prevent a collision. DISTRONIC PLUS¹ proximity control uses radar to help the driver maintain a

preset distance between the car and the vehicle in front, making the driver’s job easier in either moving or stop-and-go traffic. The Driving Assistance package Plus is rounded off with Brake Assist BAS PLUS¹ and PRE-SAFE[®] Brake¹ – for a reassuring sense of safety on every trip.



Active Lane Keeping Assist can make the steering wheel vibrate if the vehicle drifts unintentionally across lane markings.



Active Blind Spot Assist monitors the difficult-to-see areas to the left and right of the car.

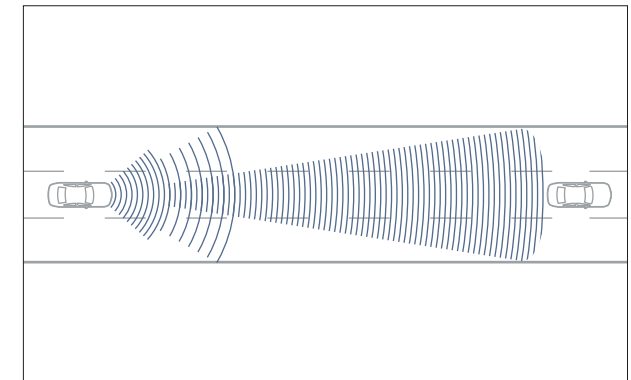

DISTRONIC PLUS can support drivers in automatically keeping their vehicle at a safe distance from the vehicle in front.

In the event of danger: PRE-SAFE® Brake¹ and BAS PLUS¹ (both part of the optional Driving Assistance package Plus¹). PRE-SAFE® Brake first provides the driver with visual and acoustic warnings if the risk of a collision is detected. In this phase, BAS PLUS determines the brake pressure required to avoid a collision. If the braking force applied by the driver is insufficient, BAS PLUS increases the braking pressure automatically so as to make optimum use of the remaining distance available whilst also giving the driver behind a better chance of avoiding a rear-end collision. If the Mercedes driver fails to respond to the signal, PRE-SAFE® Brake initiates autonomous partial braking, giving them a haptic warning. The PRE-SAFE® system simultaneously triggers protective measures for a possible collision. If there is still no response from the driver, autonomous emergency braking can be initiated, meaning that the severity of the impact and therefore the consequences of the accident can be reduced significantly.

In the event of danger: PRE-SAFE® system¹ (option). This anticipatory occupant protection system is able to detect certain critical driving situations in advance and activate preventive measures. Once such a situation has been identified, depending on the driving situation and the vehicle's scope of equipment, the front seat belts are tensioned and the side windows and sliding roof are closed so as to ensure that the seat belts and airbags function to full effect in the event of an impact. When the optional multicontour seats are fitted, air cushions are activated in a matter of seconds to hold the occupants in place on the front seats. With the separately available Memory package, the front passenger seat is additionally moved to a position offering greater protection in accident conditions. If the

accident is avoided, the seat belts are slackened again and the system returns to standby mode.

In an accident: NECK-PRO head restraints (standard). The crash-responsive NECK-PRO head restraints can help to reduce the risk of whiplash injury by moving forwards and upwards to support the heads of the front occupants at an earlier stage in the event of a rear impact.

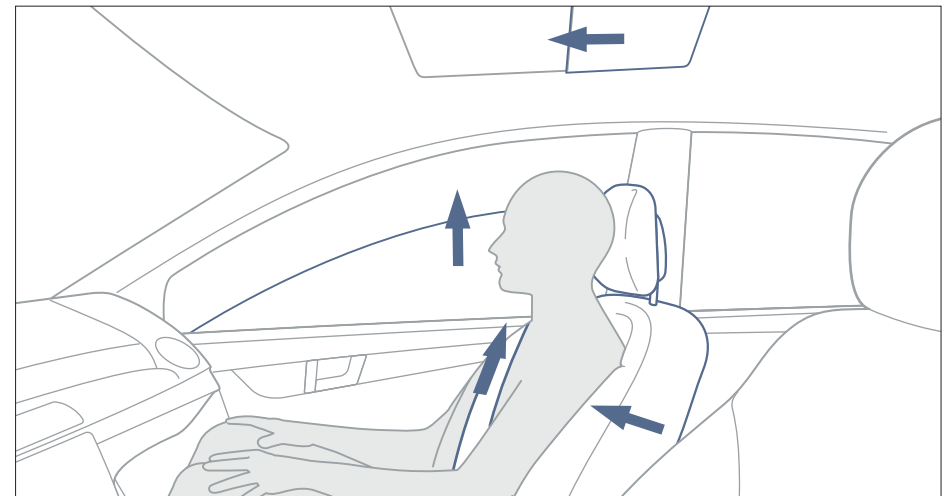

PRE-SAFE® can initiate preventive measures to provide better protection for the occupants in a hazardous situation.

¹ Integral component of Mercedes-Benz Intelligent Drive. More on page 36.

In an accident: restraint systems (standard). Mercedes-Benz optimises interaction between the 3-point seat belts, belt tensioners, belt force limiters and airbags to minimise injuries. Up to nine airbags are installed to protect the occupants: front airbags, which can deploy in two stages depending on the predicted impact severity, as well as sidebags and window-bags. The kneebag can further reduce the forces exerted on the driver during an accident. Sidebags for the rear seats are also available as an option. If the airbag control unit detects an accident, the seat belts are tightened automatically almost instantly to hold the occupants

firmly in their seats – this is also a standard feature of the rear seat belts. The belt force limiter, on the other hand, slackens the belt according to the particular situation so that not too much force is exerted on the rib cage of any of the occupants.

After an accident: Mercedes-Benz emergency call system (part of COMAND Online).

The system can send an automatic emergency call via an operational telephone connected to the vehicle as soon as the restraint system detects an accident. At the same time GPS positioning data and other information on the vehicle are transmitted to the Mercedes-Benz emergency call centre. A voice connection is then established. The emergency call system can also be triggered manually.

Measures after an accident. In order to reduce consequential damage and, where necessary, to support the rescue of the occupants, Mercedes-Benz has developed further measures. These include the automatic engine cut-off or the activation of the hazard warning lamps and interior emergency illumination. The central locking also opens automatically, and crash joints between the door and the wing make it easier to open the doors after a front impact. In addition Mercedes-Benz makes Guidelines for Rescue Services available; helpers all over the world can download them from the internet in various languages at www.mercedes-benz.de/rettungslleitfaden. As you can see, at Mercedes-Benz consideration has been given to safety in every situation.

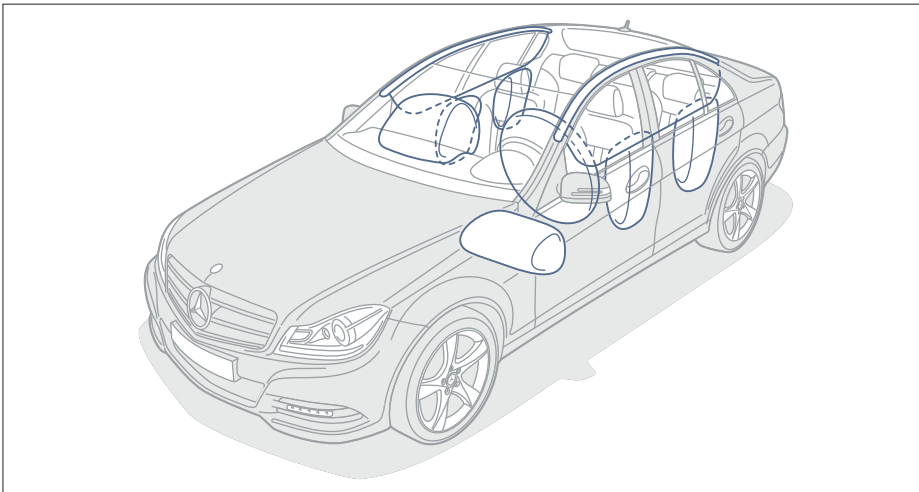

The seven standard airbags are among the restraint systems that can help to mitigate the consequences of accidents.

Multimedia systems.

The C-Class offers a full range of entertainment systems, from the Audio 20 and the optional Audio 20 system with Becker® MAP PILOT to the optional COMAND Online multimedia system.



COMAND Online is a combination of audio and navigation systems as well as telephone and internet functions. All of the main settings can also be programmed using the LINGUATRONIC voice-operated control system.

COMAND Online (option). The multimedia system boasts a high-resolution 17.8 cm colour display. The system's functions include a radio, speed-sensitive volume control, the Music Register with a 10 GB hard disc and hard-disc navigation. What's more, for 3 years from the initial registration it also includes free updates for European map data. The best in entertainment comes courtesy of the DVD drive which plays CDs and MP3 content as well as video and audio DVDs. The online function with integrated web browser facilitates access to the internet plus various mobile services from Mercedes-Benz via an internet-capable mobile phone. LIVE TRAFFIC, for example, receives up-to-the-minute, accurate traffic information which is integrated directly in the navigation system. A USB socket and a slot for SD memory cards as well as a Bluetooth® interface enable connections to external data carriers and a mobile phone. The system is operated via a Controller that can be used intuitively and also via the buttons on the multifunction steering wheel. LINGUATRONIC allows the system to be operated by voice entry.

Audio 20 CD (standard). The Audio 20 system combines the key functions of a fully-fledged entertainment system: radio, CD player, MP3 player as well as USB and Bluetooth® interfaces. Following the introduction of the innovative telematics generation, the screen diagonal was increased to 14.7 cm. Optional extras also include a 6-disc CD changer and the universal Media Interface.



The colour display in the centre console shows all the information – such as the available radio stations – from the entertainment system.

Harman Kardon® Logic 7® surround sound system (option). Equipped with 12 loudspeakers, including a woofer, and a 9-channel DSP sound amplifier, this optionally available Dolby Digital 5.1 system has an output of 450 watts, giving you first-class acoustics in all seats when combined with the COMAND Online system. 3D surround sound and speed-sensitive volume control ensure constant listening pleasure.



12 loudspeakers and 450 watts for the ultimate listening experience: the Harman Kardon® Logic 7® surround sound system.

Becker® MAP PILOT (option). The Becker® MAP PILOT has everything you look for in a fully featured navigation system. Fully integral, it can be operated via the central control and also the display of the Audio 20 CD. What's more, it can be individualised by downloading current map data and additional functions. A cradle for the control unit in the glove compartment allows the system to be used flexibly and to be removed from the vehicle.



The extensive functions provided by the Becker® MAP PILOT are indicated on the Audio 20 CD display and the instrument cluster.

Assistance systems.

The C-Class has always been a car in which convenience has played a major role. And thanks to convenience-enhancing assistance systems such as Speed Limit Assist, Parking Guidance and the reversing camera, it more than lives up to this reputation.



Speed Limit Assist can even indicate temporary speed limits.

Speed Limit Assist (included with the optional COMAND Online system). Speed Limit Assist can detect speed-limit signs and display them as symbols on the instrument cluster and in COMAND Online on the navigation screen. They remain displayed there until the speed restriction is lifted or changed. To this end, a windscreen-mounted camera monitors the area in front of the car on a permanent basis. The camera can filter out round traffic signs, be they speed-limit signs at the side of the road or on a gantry above the road. To detect the signs, the system also draws on the data stored in the navigation system's digital map, thus also enabling it to take account of the vehicle entering or leaving urban areas. Speed Limit Assist is especially helpful on routes with variable speed limits or road works.

Reversing camera¹ (option). The reversing camera with wide-angle lens monitors the area directly behind the car and sends the images to the COMAND display. It is activated when reverse gear is engaged, thus enhancing safety when reversing into a parking space. The reversing camera is only available in conjunction with COMAND Online.



The reversing camera provides additional assistance when reversing into a parking space.

PARKTRONIC¹, incl. Parking Guidance (option). PARKTRONIC can warn the driver automatically if space in front of or behind the car becomes tight when parking or manoeuvring. The system operates on the echo sounder principle. Sensors on the front and rear bumpers emit ultrasound signals which are then reflected by other vehicles or obstacles. A micro-computer calculates the current distance and informs the driver by means of displays in the instrument cluster and acoustic signals. Parking damage can therefore be prevented.



The display in the instrument cluster gives you a clear picture of the parking manoeuvres at all times.

Parking Guidance can help the driver when looking for a parking space and also when parking: ultrasonic sensors in the side front bumper can measure the length of parking spaces parallel to the car automatically if the car drives past at a speed of 35 km/h or less. Parking Guidance starts once a suitable space has been found and reverse gear has been engaged. It provides the driver with visual and acoustic instructions via the instrument cluster regarding the correct steering angle as well as the turn-in and turn-back points. If the car is not straight after the first reversing move, the system also helps the driver make the necessary further manoeuvres.

¹ Integral component of Mercedes-Benz Intelligent Drive. More on page 36.

Climate control.

An ideal interior climate is paramount when it comes to ensuring a high level of driver-fitness safety. This is why the climate control system for the C-Class is exceptionally versatile and can be adjusted to meet the needs of each individual occupant.



The THERMOTRONIC automatic climate control system operates extremely effectively without producing draughts. It is easy to use, fast to respond and quiet. The control wheels have been ergonomically designed and finished with a silver-chrome surface for the C-Class.

THERMOTRONIC (option). The THERMOTRONIC 3-zone luxury automatic climate control system allows the driver, front passenger and rear passengers each to set the temperature and air distribution using their own controls. A booster blower beneath the centre console ensures the ideal temperature in the rear. What's more, the automatic mode can be adapted to meet individual needs at the push of a button. There are three climate styles to select from: DIFFUSE, MEDIUM or FOCUS. Automatic activation of recirculated air mode maintains the air quality in the vehicle.

THERMATIC (standard). The THERMATIC automatic climate control system can control the temperature separately for the driver and front passenger and adjust the ventilation automatically. A solar sensor on the windscreen can record the intensity and direction of the sun's rays, for example. Further standard features include air recirculation, a cooled glove compartment and an activated charcoal particulate filter which filters out dust, pollen and odours. There are two additional air outlets for the rear compartment on the rear end of the centre console.



THERMATIC operates on the basis of sensor information including data for interior and exterior temperature as well as air humidity.

Rear climate control (included with THERMOTRONIC automatic climate control system). The optional THERMOTRONIC automatic climate control system includes controls for the passengers in the rear seats: the airflow speed, airflow direction and temperature can be easily controlled at the push of a button, thus enhancing climate comfort for the rear occupants.



The desired temperature and airflow can be set precisely using the separate controls in the rear.

Seats.

Seats that meet an exceptionally wide range of requirements in terms of seating comfort, ergonomic design and safety have been developed for the C-Class.



Seats. The seats in the C-Class are good news for the front and rear passengers, as they are exceptionally comfortable and provide plenty of legroom and shoulder room. The standard-fit driver's seat is partially power-adjustable and features manually adjustable lumbar support. Full power adjustment for the driver's seat is available as an optional extra. Line-specific colour concepts, designs and fluting add attractive visual touches. The AVANTGARDE line is available with upholstery in the colour shade cappuccino or fine sahara beige, while the standard version impresses with the combination black/blue. Further optional extras include 1/3 : 2/3 split-folding rear seats (standard for the estate).

Climatised seats for driver and front passenger (option). The airflow for the climatised seats has been configured to ensure a well-balanced seat climate. There is a choice of three-stage seat heating and active ventilation for cooling the seats. The output of the climatised seats is reduced automatically after certain periods.



The ventilation and heating for the climatised seats can be adjusted separately.

Memory package (option). The front seats are available with full power adjustment as an optional extra. The switches for this are clearly arranged in the doors. If the Memory package is ordered, three position settings can be stored for the driver's seat, steering column and mirrors. Both front seats also feature 4-way lumbar support.



The Memory package remembers up to three positions for the driver's seat, steering column and exterior mirrors.

Space.

The C-Class Estate combines luxury and sportiness with generous interior space.



Fully folding down the rear seats allows a load compartment capacity of some 1500 litres with a practically flat load area.

Load compartment. The dimensions of the C-Class Estate – length 4.61 metres, width 1.77 metres and height 1.46 metres – form the basis for its load compartment. There's plenty of space for up to five people in the estate – with even the rear seats offering passengers generous kneeroom. Fully folding down the rear bench seat gives stowage space of up to 1500 litres with a practically flat load area. The rear seats can be folded extremely easily in the ratio 1/3 : 2/3. The C-Class Estate sets another benchmark when it comes to payload, as it is capable of carrying up to 540 kilograms with ease. A stainless-steel cover on the load compartment sill helps prevent bumper and load compartment scratches or other damage when loading and unloading the car.

Load compartment cover (standard). A combined load compartment cover and net is positioned in the C-pillar area. The load compartment cover, colour-coded to match the interior appointments, shields luggage from the sun and prying eyes. To divide off the load compartment and protect the occupants in the event of sudden braking manoeuvres, the safety net can be attached between the B-pillars or the C-pillars, depending on the size of the load being carried. Further features in the load compartment enable items to be stowed tidily, e.g. two nets integrated in the side panelling for the practical stowage of smaller items, two retractable bag hooks, four load retainers and a 12-volt socket providing an additional power supply in the load compartment.



The rear bench seat can be split 2/3 with just one hand to give a versatile stowage space.



The load compartment cover shields the contents of the luggage compartment from the sun and from prying eyes.

Load compartment management.

The C-Class Estate has plenty of stowage space. Intelligent solutions – such as the EASY-PACK load compartment management system – enable it to be used efficiently.



The load compartment rails in the EASY-PACK load-securing kit can help to secure the load.

EASY-PACK load-securing kit (option). The EASY-PACK load-securing kit consists of two load compartment rails, which are secured to the load compartment floor on the left and right and are used to hold load-securing elements. The telescopic bar included in the package allows the load compartment to be divided flexibly into different zones or bulky items to be secured. Bulky or round items can be secured to the load compartment sides using the retractable load-restraining belt. The four mounting elements also supplied and four load retainers already fitted as standard allow flexible use and easy handling for securing a wide range of luggage and cargo.

Self-levelling suspension (option). The self-levelling rear suspension keeps the rear of the car at the specified level, even when the car is laden, and therefore has a positive effect on driving stability and driving safety – especially when towing a trailer. Another benefit for the occupants is a consistently high level of suspension comfort when the car is loaded within the permissible axle load limits.

EASY-PACK tailgate (option). The EASY-PACK tailgate can be operated electro-mechanically for convenience. It can be opened at the push of a button from the driver's seat, at the tailgate or by using the ignition key. It can be closed again using a switch on the tailgate. In this case, it can also be stopped in a lower position. Furthermore, the tailgate can be made to open only as far as the roof edge by adjusting the setting on the instrument cluster. Independently of this, the tailgate can also be opened and closed manually using the release handle on the tailgate.



You can also open and close the EASY-PACK tailgate in a low position at the push of a button.



C 63 AMG exterior.

The expressive exterior of the C 63 AMG reflects its inner values perfectly: this high-performance vehicle developing 336 kW (457 hp) features an AMG front and rear apron, side sill panels, and flared front wings. The powerful look includes features such as the unique AMG LED daytime running lamps, the front apron with a high-gloss black cross-strut, the radiator grille with a chrome louvre and the unique AMG bonnet with powerdomes. → www.mercedes-amg.com

Exterior

AMG 5-twin-spoke light-alloy wheels, painted titanium grey with a high-sheen finish, with 235/40 R 18 front tyres and 255/35 R 18 rear tyres

AMG bodystyling, consisting of front apron with side air outlets, side sill panels and diffuser-style rear apron

AMG high-performance braking system with 360x36 mm front brake discs and 330x26 mm rear brake discs

AMG spoiler lip on the boot lid (saloon)

AMG sports exhaust system with two chromed twin tailpipes

AMG-specific LED daytime running lamps

Distinctive, flared front wings with "6.3 AMG" lettering

Tail lights with LED technology

Unique AMG bonnet with powerdomes

Unique AMG front apron with cross strut in high-gloss black

Unique AMG radiator grille with a single chromed louvre





C 63 AMG interior.

Inside, too, the C 63 AMG impresses with sporty touches throughout. At its heart is the AMG tube-design instrument cluster with colour display, AMG Start-up indicator and three-spoke AMG performance steering wheel trimmed in nappa leather and featuring perforations in the grip area, silver-coloured aluminium shift paddles and flattened top and bottom sections. Exclusive, ergonomic AMG sports seats in ARTICO man-made leather/black DINAMICA micro-fibre (optionally available in single- or two-tone design leather) ensure a high level of seating comfort. A black head-lining, dark longitudinal-grain aluminium trim and brushed stainless-steel AMG door sill panels and AMG sports pedals complete the dynamic ambience.

Interior

AMG door sill panels in brushed stainless steel

AMG instrument cluster with high-resolution 11.4 cm colour display, incl. RACETIMER and AMG Start-up indicator

AMG performance sports steering wheel in nappa leather, with flattened top and bottom sections as well as silver-coloured aluminium shift paddles

AMG speed-sensitive sports steering

AMG sports seats in black ARTICO man-made leather/DINAMICA microfibre
ATTENTION ASSIST¹

Brushed stainless-steel sports pedals with rubber studs

Dark longitudinal-grain aluminium trim

Rotary switch to select four transmission modes and Race Start function



¹ Integral component of Mercedes-Benz Intelligent Drive. More on page 36.

C 63 AMG technology.

The AMG 6.3-litre V8 engine and the AMG SPEEDSHIFT MCT 7-speed sports transmission offer an emotive driving feel and driving dynamics at the highest level. Yet when it comes to choosing a sporty or comfort-oriented driving style, the driver always has the final say in the sports saloon. → www.mercedes-amg.com

AMG 6.3-litre V8 engine. A high-revving naturally aspirated engine with thoroughbred motor-racing technology: the vertical arrangement of the intake and exhaust ducts as well as the magnesium variable-intake manifold with two integral throttle valves ensure optimum charging of the eight cylinders. Further high-tech features include variable camshaft adjustment, the four-valve-per-cylinder design, the stiff aluminium crankcase and the low-friction TWAS (twin-wire-arc-spraying) coating used for the cylinder walls. The V8 powerplant develops 336 kW (457 hp) at 6800 rpm, delivering impressive pulling power and a torque of up to 600 Nm at 5000 rpm. Ideal ingredients for powerful acceleration in every engine speed range, as the driver has over 500 Nm on tap between 2000 and 6250 rpm. The AMG Performance package boosts the output by 22 kW (30 hp) to 358 kW (487 hp), enabling the car to accelerate from 0 to 100 km/h in an impressive 4.3 s (4.4 s for the estate).

AMG sports suspension. The specially tuned AMG sports suspension delivers excitement thanks to increased agility, enhanced lateral acceleration potential and improved overall ride comfort. Together with the AMG 5-twin-spoke light-alloy wheels with 235/40 R 18 front tyres and 255/35 R 18 rear tyres, the specific three-link front suspension with a wider track, the AMG speed-sensitive sports steering and the three-stage ESP^{®1}, it ensures superlative driving dynamics and thrilling driving enjoyment. The AMG speed-sensitive sports steering has an even more direct ratio and therefore offers greater steering precision at high cornering speeds. The AMG sport suspension's stiff springs and gas-pressure shock absorbers ensure optimum road feel and minimise body movements. The AMG sports suspension therefore combines driving dynamics at the highest level with hallmark Mercedes long-distance comfort – and thus displays the characteristic attributes of a true AMG. The Electronic

Stability Program ESP[®] has been specially adapted in line with the high level of driving dynamics, as it allows the driver to select the level of assistance provided by the dynamic handling control system by choosing one of three different control settings: ON, OFF and SPORT-HANDLING MODE. The activated setting is shown on the AMG instrument cluster's central display. The AMG high-performance braking system featuring large, internally ventilated and perforated brake discs ensures good levels of deceleration and fade resistance. Not to mention perfect brake control and short stopping distances. An AMG performance suspension is available as a further option. A sportier configuration of springs and dampers allows the suspension to respond even faster and more directly, so that it meets even the most demanding expectations in terms of driving dynamics.

¹ Integral component of Mercedes-Benz Intelligent Drive. More on page 36.

AMG SPEEDSHIFT MCT 7-speed sports transmission.

Equipped with AMG aluminium steering-wheel gearshift paddles, four modes and a Race Start function, the 7-speed automatic transmission delivers enhanced driving dynamics, higher efficiency and up to 10 percent lower fuel consumption than the predecessor model. The Race Start function allows the driver to call up the maximum acceleration potential with optimum traction. The “S” (Sport), “S+” (Sport Plus), “C” (Comfort) and “M” (Manual) modes each have different gear-change characteristics and speeds: gear changes in “S” and “S+” modes are around 20 and 40 percent quicker than in “C” mode respectively – while in “M” mode gear changes take just 100 milliseconds, making them some 50 percent faster. A push of a button activates the desired driving mode: distinctly sporty or more comfort-oriented. There is also an automatic double-declutching function when downshifting, which provides an emotive sound experience as well as reducing power-off effects. This function has a positive effect when braking on the approach to bends in particular.

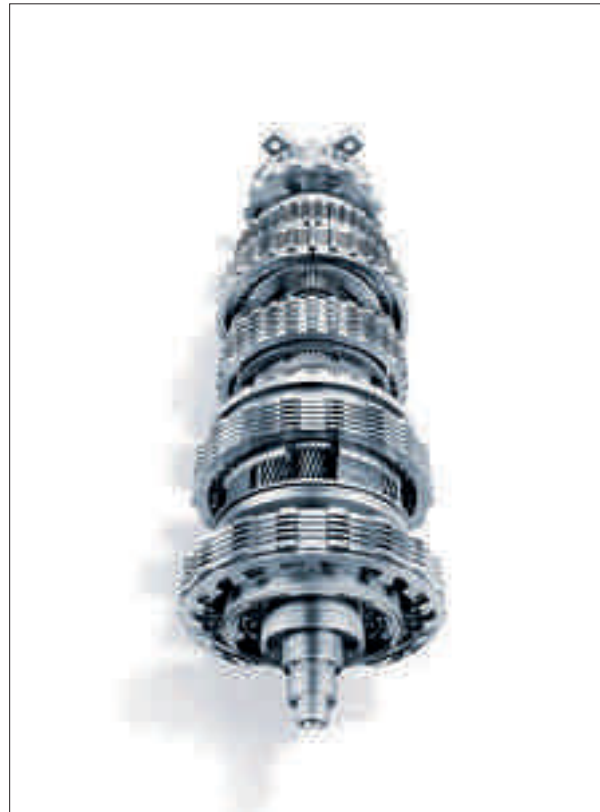

The AMG SPEEDSHIFT MCT 7-speed sports transmission offers customised modes for maximum driving pleasure.



Motor-racing technology gives the AMG 6.3-litre V8 engine maximum agility.



AMG Performance Studio.

The AMG Performance Studio offers a range of options for further enhancing the dynamic aspects of the C 63 AMG. A prime example of this is the AMG Performance package, which boosts the output by 22 kW (30 hp) to 358 kW (487 hp) and also includes a variable intake manifold painted in titanium grey, the AMG high-performance compound brake system with compound front brake discs, red-painted brake callipers, the AMG carbon-fibre spoiler lip on the boot lid and the AMG performance steering wheel in nappa leather/DINAMICA microfibre.

Fans of motorsport and technology will appreciate one special highlight of the AMG Performance Media system in particular: the system displays data specific to the vehicle and route information, which can also be evaluated. There is no other system in this form on the market. What's more, the range of additional options includes an AMG rear-axle locking differential and three further AMG light-alloy wheel designs.

The AMG Driver's package allows an electronically governed top speed of 280 km/h and includes participation in driving training at the AMG Driving Academy. What's more, the AMG Performance Studio can meet customer requests for personalised vehicles as well as special one-off models.





Standard equipment.

When it comes to standard equipment, the C-Class impresses with an array of key comfort- and safety-related features. Not to mention high-quality visual attributes such as LED tail lights, a chromed radiator grille and a harmonious interior.



Exterior

7-spoke light-alloy wheels with 195/60 R 16 tyres (not for estate)
or 205/55 R 16 tyres (depending on engine version)

Beltline trim strip in matt black

Bumpers and side trim in vehicle colour

LED tail lights

Louvred radiator, chromed, star on bonnet

Roof rails in black (estate only)

Interior

Black backplate

Brighton fabric upholstery

Door openers with silver-chrome surface

High-gloss black piano-lacquer-look trim

Multifunction steering wheel and shift/selector lever in nappa leather

Seat design with large panels and horizontal seamlines





The upholstery is available in Brighton fabric as standard or ARTICO man-made leather as an option. There are also four upholstery colours to choose from (two in the case of ARTICO man-made leather), with the same upholstery being used for the inside of the doors in each case. The remainder of the interior is in elegant black, while the trim has a fine piano-lacquer-look finish.

black

021 Brighton fabric

121 ARTICO man-made leather (option)

alpaca grey

028 Brighton fabric

128 ARTICO man-made leather (option)

black/blue

062 Brighton fabric

black/beige

065 Brighton fabric

Trim

H80 High-gloss black piano-lacquer look

734 Eucalyptus wood (option)

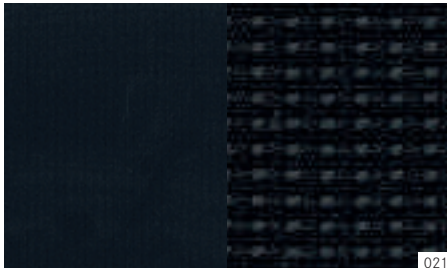

021

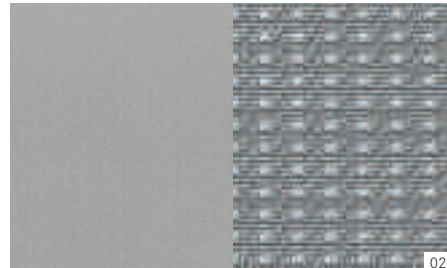

028

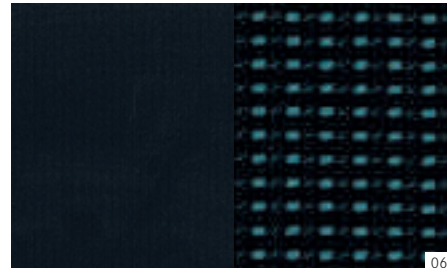

062

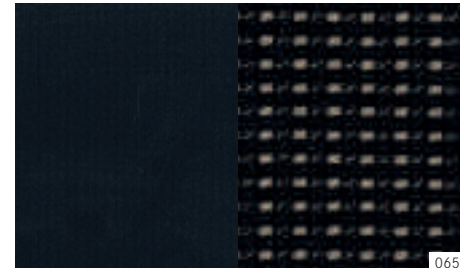

065



121



128



H80



H80



H80



H80



734



734



734



734



ELEGANCE line.

The optional ELEGANCE line emphasises the elegant side of the C-Class. Exterior features that catch the eye right away include the polished chrome highlights, while the harmonious interior features an impressive mix of fine trim, piping and a discreet tone-in-tone colour concept.

Exterior

7-twin-spoke light-alloy wheels with 205/55 R 16 or 225/45 R 17 tyres (depending on engine version)

Beltline trim strip in polished aluminium

Chrome trim strips on sides and on rear bumper

Louvred radiator with high-gloss paint finish and chrome highlights, star on the bonnet

Roof rails in aluminium (estate only)

Interior

ATTENTION ASSIST¹

Backplate in cream

Colour display (11.4 cm) in the instrument cluster

Door openers with silver-chrome surface

High-quality upholstery with stitched piping

Luxury multifunction steering wheel with silver shadow trim

Matt brown ash wood trim

NECK-PRO luxury head restraints for the front seats

Newcastle fabric upholstery

Seat design with vertical seamlines

Steering wheel and shift/selector lever in nappa leather with chrome insert



¹ Integral component of Mercedes-Benz Intelligent Drive. More on page 36.



The fabric, ARTICO man-made-leather and leather upholstery can be specified in black, almond beige or alpaca grey and combined with a fine-grained matt brown ash wood trim. The dashboard, inside of the doors and carpets match the selected interior colour perfectly.

black

- 421 Newcastle fabric
 - 121 ARTICO man-made leather (option)
 - 221 Leather (option)
-

almond beige

- 425 Newcastle fabric
 - 125 ARTICO man-made leather (option)
 - 225 Leather (option)
-

alpaca grey

- 428 Newcastle fabric
 - 128 ARTICO man-made leather (option)
 - 228 Leather (option)
-

Trim

- H06 Matt brown ash wood
 - 731 Brown burr walnut wood (option)
-

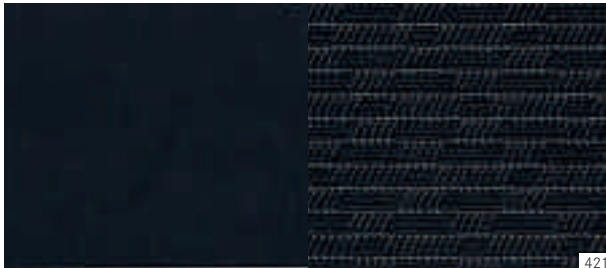

421



425

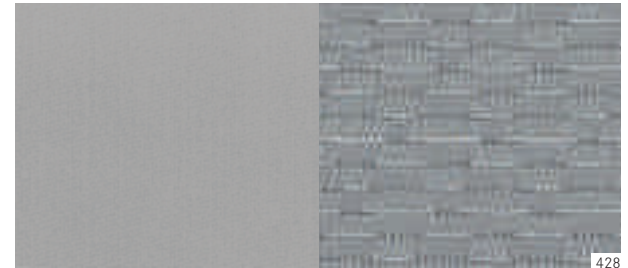

428



121
221

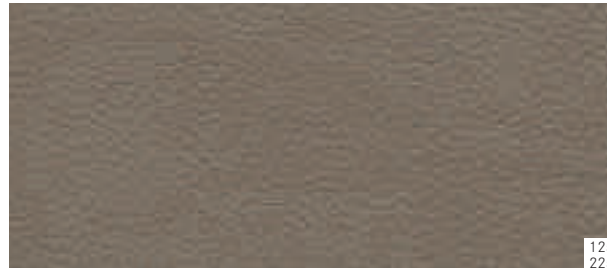

125
225



128
228



H06



H06



H06



731



731



731



AVANTGARDE line.

The optional AVANTGARDE line lends the C-Class a distinctly sporty character. The exterior is more dynamic, more striking and bolder, while colour contrasts in the interior add dynamic touches.

Exterior

5-twin-spoke light-alloy wheels with 225/45 R 17 tyres

Beltline trim strip in polished aluminium

Chrome trim strips on sides and on rear bumper

Louvred radiator in matt brilliant silver, with chrome highlights and integral star

Roof rails in aluminium (estate only)

Interior

ARTICO man-made leather/Liverpool fabric upholstery

ATTENTION ASSIST¹

Colour display (11.4 cm) in the instrument cluster

Dark longitudinal-grain aluminium trim

Door openers with silver-chrome surface

Seat design with horizontal seamlines

Shift/selector lever in nappa leather with chrome insert

Sports steering wheel (12-button) in nappa leather, perforated grip area, matt silver-look trim, silver backplate



¹ Integral component of Mercedes-Benz Intelligent Drive. More on page 36.



The upholstery is trimmed in a combination of ARTICO man-made leather and Liverpool fabric as standard or in genuine leather as an option. The high-quality interior is trimmed in the selected colour. The dark longitudinal-grain aluminium trim, which comes as standard, emphasises the sporty ambience.

black/black

- 721 ARTICO man-made leather/Liverpool fabric
- 121 ARTICO man-made leather (option)
- 221 Leather (option)

almond beige/black

- 125 ARTICO man-made leather (option)

alpaca grey/black

- 728 ARTICO man-made leather/Liverpool fabric
- 128 ARTICO man-made leather (option)
- 228 Leather (option)

cappuccino/black

- 224 Leather (option)

sahara beige/black

- 235 Leather (option)

Trim

- 739 Dark longitudinal-grain aluminium trim
 - 736 High-gloss black ash wood (option)
-

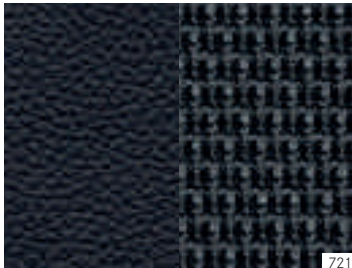

721



728



121
221

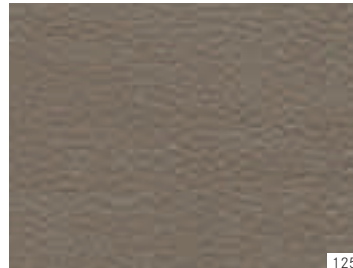

125



128
228

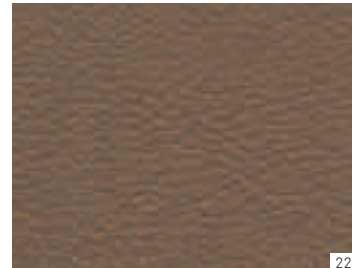

224



235



739



739



739



739



739



736



736



736



736



736



AMG Sports package.

The dynamic appeal of the C-Class becomes even more pronounced with the optional AMG Sports package. The exciting and distinctive AMG bodystyling consists of the front apron, side sill panels and rear apron. AMG light-alloy wheels featuring 5-twin-spoke styling, a high-sheen finish and mixed-size tyres (front 225/45 R 17 and rear 245/40 R 17) as well as a sports suspension lowered by 15 millimetres complete the sporty look.

Exterior

AMG 5-twin-spoke light-alloy wheels with a high-sheen finish, with 225/45 R 17 front tyres and 245/40 R 17 rear tyres

AMG bodystyling, comprising front apron, side sill panels and rear apron

Fog lamps and LED daytime running lamps, double-round design with chrome surround

Lowered sports suspension

Perforated front brake discs, brake callipers with "Mercedes-Benz" lettering

Polished stainless-steel exhaust tailpipe trim

Speed-sensitive sports steering

A true AMG when it comes to inner values, too: exciting features which catch the eye immediately include front sports seats, a 3-spoke multifunction sports steering wheel in nappa leather with a flattened bottom section and gearshift paddles (when fitted in conjunction with an automatic transmission), and an aluminium-look shift/selecter lever with a leather gaiter. The look of the instrument cluster is based on the tube-type design found in the C 63 AMG. Brushed stainless-steel sports pedals, black floor mats with "AMG" lettering and a black headlining are further highlights of the sporty interior.

Interior

3-spoke multifunction sports steering wheel in nappa leather, with flattened bottom section

ATTENTION ASSIST¹

Brushed stainless-steel sports pedals with rubber studs

Floor mats in black with "AMG" lettering

Front sports seats with ARTICO man-made leather/Liverpool fabric upholstery in black or alpaca grey, optionally available in leather with additional colour combinations

Headlining in black

Shift/selecter lever in aluminium look with leather gaiter

Steering-wheel gearshift paddles and manual shift mode in conjunction with automatic transmission



¹ Integral component of Mercedes-Benz Intelligent Drive. More on page 36.



AMG Sports package Plus.

The dynamic lines of the C-Class reveal their full expressive potential with the AMG Sports package Plus. This brings out the sporty essence of the model by applying the inimitable AMG treatment in numerous areas. In specific terms this means: AMG bodystyling with front and rear aprons as well as side sill panels, an AMG spoiler lip in the vehicle colour on the boot lid of the saloon and exclusive AMG 7-twin-spoke light-alloy wheels. The systematic application of the AMG treatment also extends to the details: perforated front brake discs, brake callipers with “Mercedes-Benz” lettering and polished stainless-steel tailpipe trims. But it is not just the vehicle’s looks that are enhanced. The speed-sensitive sports steering and sports suspension ensure that the driving dynamics deliver all that the appearance promises.

Exterior

AMG 7-twin-spoke light-alloy wheels, painted high-gloss black with a high-sheen finish

AMG bodystyling comprising front apron, side sill panels and rear apron

AMG spoiler lip on the boot lid

Brake callipers with “Mercedes-Benz” lettering, perforated front brake discs

Lowered sports suspension

Speed-sensitive sports steering

Tailpipe trim in polished stainless steel

The sporty theme continues inside the vehicle: red topstitching on the sports seats and red designo seat belts are complemented by silver-effect shift paddles on the 3-spoke multifunction sports steering wheel. Aluminium trim as well as black floor mats with “AMG” lettering and a red surround complete the interior, as do the brushed stainless-steel sports pedals. Together, these features add a distinctly sporty dimension to every trip – even the daily commute.

Interior

3-spoke multifunction sports steering wheel with flattened bottom section and twelve buttons, in nappa leather with red contrasting topstitching, perforated in the grip area

AMG floor mats in black with red surround

Armrest in the centre console, door centre panels and selector lever gaiter with contrasting red topstitching

ATTENTION ASSIST¹

Brushed stainless-steel sports pedals with rubber studs (including foot-operated parking brake)

Dark longitudinal-grain aluminium trim

designo seat belts in red (can be deselected in favour of black seat belts)

Headlining in black

Instrument cluster with 11.4 cm high-resolution colour display

Sports seats for driver and front passenger

Steering-wheel gearshift paddles in silver (only with automatic transmission)

Upholstery in ARTICO man-made leather/DINAMICA microfibre in black



¹ Integral component of Mercedes-Benz Intelligent Drive. More on page 36.

designo.

The designo range allows you to design the C-Class to an even higher standard and to your own taste. → www.mercedes-benz.com/designo

The exclusive designo two-tone leather appointments are available in several combinations – designo porcelain/black, designo sand/black or designo classic red/black – for both the saloon and the estate. In addition to the seats in the characteristic two-tone design, the armrests in the doors as well as in the centre console are finished in designo black leather. The door centre panels are trimmed in the appropriate designo colour. Rounding off these appointments is a headlining in black fabric. An optional two-tone designo steering wheel offers the perfect complement to this exclusive designo interior.



The high-quality designo interior can be further enhanced by adding the extended appointments in designo black leather, including the upper section of the dashboard and the beltlines on the doors. Furthermore, an AMG carbon fibre/piano-lacquer-look trim in high-gloss black is available as an optional extra. In addition, the interior of the C 63 AMG comes with the option of exclusive designo single-tone leather upholstery in black, sand, porcelain or classic red, giving discerning customers further options for making the car even more individual and exclusive.

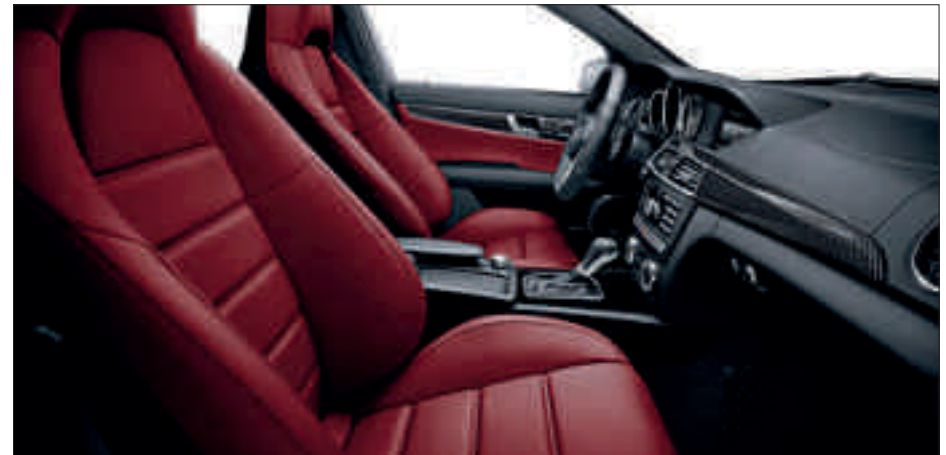

Style package.

The Style package further emphasises the sporty and individual interior style of the C-Class.

The Style package comprises a number of high-quality, harmoniously combined details. The upholstery in perforated black ARTICO man-made leather with contrasting porcelain-coloured topstitching catches the eye straight away, while the 3-spoke multifunction sports steering

wheel with twelve buttons is trimmed in leather with a two-tone look, the lower section being finished in porcelain-coloured leather. The surface is perforated so that it is even easier to grip. This style is consistently matched by the trim, which is also in porcelain colour but with a piano

lacquer look. The armrests, the door panelling, the shift/selector lever gaiter and the centre console are accentuated by contrasting topstitching in porcelain colour, while the floor mats have a porcelain-coloured piping edge.



Handcrafted perfection: the Style package individualises the interior of the C-Class.



All the details add up to an impressive whole: the trim is in a shining porcelain piano-lacquer look.



Gearshift gaiter with porcelain-coloured contrasting topstitching.

Standard equipment | Selection.



Audio 20 CD.



THERMATIC automatic climate control.



Standard steering wheel in nappa leather.



Roof rails in black (for estate only).



Door sill panel.



Split rear bench seat (for estate only).



LED tail lights.



Load compartment cover (for estate only).

Optional extras | Selection.



Sliding sunroof.



Panoramic sliding sunroof.



Style package.



Becker® MAP PILOT.



EASY-PACK tailgate (for estate only).

ATTENTION ASSIST¹.

Trailer coupling.



COMAND Online.

Wheels.



7-spoke light-alloy wheels with 195/60 R 16 tyres (Code R20)¹ or 205/55 R 16 tyres (Code R75)².



5-twin-spoke light-alloy wheels with 225/45 R 17 tyres (standard for AVANTGARDE models, Code 44R).



7-spoke light-alloy wheels with 225/45 R 17 front tyres and 245/40 R 17 rear tyres, painted high-gloss black and with a high-sheen finish (optional, Code 74R).



5-twin-spoke light-alloy wheels with 225/40 R 18 front tyres and 255/35 R 18 rear tyres (optional, Code R70).



7-twin-spoke light-alloy wheels with 205/55 R 16 tyres (Code R27)³ or 225/45 R 17 tyres (Code 26R)⁴.



5-twin-spoke light-alloy wheels with 225/45 R 17 front tyres and 245/40 R 17 rear tyres (optional, Code R95).



Multi-spoke light-alloy wheels with 225/45 R 17 front tyres and 245/40 R 17 rear tyres (optional, Code 56R).



AMG 5-twin-spoke light-alloy wheels with 225/45 R 17 front tyres and 245/40 R 17 rear tyres, with a high-sheen finish (part of the optional AMG Sports package, not for C 63 AMG, Code 784).

¹ Standard for C 180 CDI, C 200 CDI and C 180 saloons. ² Standard for 4-cylinder saloons starting with the C 220 CDI or C 200 and for 4-cylinder estates. ³ Standard for 4-cylinder ELEGANCE models. ⁴ Standard for 6-cylinder ELEGANCE models, optional for 4-cylinder models.



AMG 7-spoke light-alloy wheels with 225/40 R 18 front and 255/35 R 18 rear tyres, painted high-gloss black and with a high-sheen finish (standard for AMG Sports package Plus, Code 760).



AMG 5-twin-spoke light-alloy wheels with 225/40 R 18 front tyres and 255/35 R 18 rear tyres, with a high-sheen finish (optional, not for C 63 AMG, Code 786).



AMG 5-spoke light-alloy wheels with 235/40 R 18 front tyres and 255/35 R 18 rear tyres, painted in titanium grey with a high-sheen finish (optional for C 63 AMG, Code 790).



AMG multi-spoke light-alloy wheels with 235/35 R 19 front tyres and 255/30 R 19 rear tyres, painted matt black with rim flange in high-sheen finish (optional for C 63 AMG, Code 797).



AMG 7-spoke light-alloy wheels with 225/40 R 18 front tyres and 255/35 R 18 rear tyres, with a high-sheen finish (optional, not for C 63 AMG, Code 782).



AMG 5-twin-spoke light-alloy wheels with 235/40 R 18 front tyres and 255/35 R 18 rear tyres, painted in titanium grey with a high-sheen finish (standard for C 63 AMG, Code 795).



AMG multi-spoke light-alloy wheels with 235/35 R 19 front tyres and 255/30 R 19 rear tyres, painted in titanium grey with a high-sheen finish (optional for C 63 AMG, Code 788).



5-twin-spoke light-alloy wheels⁵ with 225/40 R 18 front tyres and 255/35 R 18 rear tyres, painted in himalayas grey (accessory, Code 22R, not in conjunction with AMG Sports package and C 63 AMG).

⁵ Light-alloy wheels from the genuine accessories range are supplied without tyres.



Surf the web, watch movies, listen to music: the iPad® Rear Seat Integration Plus system delivers entertainment on the move.

Genuine accessories.

A Mercedes-Benz is more than just a car. It can be a travel companion, an office, a living space. And this diversity is reflected in the Mercedes-Benz accessories range.

→ www.mercedes-benz-accessories.com

The convenient iPad® Rear Seat Integration Plus is a docking station that allows the tablet computer to be integrated into the rear of the C-Class and its battery to be charged at the same time. All the entertainment content stored on the iPad® can be used while travelling. And if the car is also equipped with the InCar Hotspot, even an iPad® not equipped with UMTS has full internet access.

Discover the full range of light-alloy wheels available in the genuine accessories range. Elegant or sporty, distinctive or dynamic – they allow you to give the C-Class the perfect finishing touch to reflect your tastes. For example with the



"Proserpina" 5-spoke light-alloy wheels with 225/45 R 17 tyres at the front and 245/40 R 17 tyres at the rear, painted sterling silver.

"Proserpina" light-alloy wheels for tyre sizes 225/45 R 17 (front) and 245/40 R 17 (rear).

The KIDFIX child seat is ideal for children aged between around 3½ and 12 years (15 to 36 kg). The raised seat and height-adjustable backrest can provide optimum side impact protection.

One particularly important aspect is the correct transport of bulky objects such as bicycles, skis or large items of luggage. There is a range of safe and flexible rack systems available for such tasks. The basic carrier bars developed



The KIDFIX child seat provides an exceptional level of safety for younger passengers.

specifically for the C-Class can be combined with a number of different roof-rack systems such as the ski and snow-board rack, the bicycle rack or the Mercedes-Benz roof boxes, which hold around 330, 400 or 450 litres and can be opened on both sides.

Please consult our special brochures or your Mercedes-Benz dealer for further details on the extensive range of genuine accessories.



The roof box is an elegant solution for stowing all manner of sports or leisure equipment from diving gear to snowboards.

Services.

Mercedes-Benz Financial Services. Our sophisticated leasing and financing products are tailored to your individual financial needs, giving you the opportunity to drive your dream car while staying financially flexible. Once you have chosen a model, you can enjoy the peace of mind of knowing that both the vehicle itself and our insurance products will keep you particularly well protected. What's more, our range of service products is designed to ensure that your car stays in top shape while offering transparent, manageable conditions. For further details, speak to your Mercedes-Benz dealer, who will be glad to go through the latest financial services and terms and conditions with you.

Mercedes-Benz mobility. Your new car comes complete with the promise of feeling safe on the road. But if you should ever need assistance, Mercedes-Benz Service24h is there to help. Just call the freephone service hotline on 00800 1 777 7777¹. The integrated telematics service, Mercedes-Benz Contact², is even more convenient: a touch of a button is all it takes to contact the Mercedes-Benz customer centre. If you wish, relevant vehicle and position-related data are transmitted at the same time, thereby allowing the centre to react quickly and provide rapid on-site assistance. Also standard with your new car at no extra charge is the Mercedes-Benz Mobilo³ mobility package. Whether you have lost your key, had a breakdown which cannot be repaired immediately or suffered damage to the vehicle due to an accident or vandalism, Mobilo helps you reach your destination – anywhere in Europe. Whatever is holding you up, you will soon be able to resume your journey.

Mercedes-Benz Museum. Discover what has been moving the world for over 125 years, and embark on a fascinating journey through automotive history in the Mercedes-Benz Museum. More than 1500 exhibits covering an area of 16,500 square metres chart the unique heritage and innovative flair of the inventor of the motor car. You will find one automotive legend after another awaiting you: unique pieces such as the oldest Mercedes still in existence from 1902, supercharged cars or the awe-inspiring Gullwings. The museum is a spectacular sight in its own right too, thanks to an architecture that breaks away from traditional concepts and creates an unprecedented sense of space. Welcome to the Mercedes-Benz Museum – a world of innovation. www.mercedes-benz-classic.com/museum



¹ Alternative: +49 69 95 30 72 77. ² Requires a factory-fitted radio, connected to an operational mobile phone. The only charge incurred is the cost of the mobile phone call to the landline network. ³ Once the mobility guarantee has expired (four years), Mobilo can be extended to provide cover in the event of breakdown and insurance claims one year at a time for a maximum of 30 years, provided that regular maintenance is carried out by your Mercedes-Benz service partner.

Test drive. The unique feeling of driving a Mercedes cannot be put into words – you have to experience it for yourself. Take a test drive and find out first hand how it feels to drive your dream car. Please contact your nearest Mercedes-Benz dealer for details.

Interactive Owner's Manual and Mercedes-Benz Guides.

The website also offers an interactive tour, enabling you to acquaint yourself with your dream car. You can view key functions in detail, gain an insight into the car's inner workings or look at the benefits of each model. For further details, go to www.mercedes-benz.de/owners-manual. The "Mercedes-Benz Guides" app lets you explore the highlights of the individual models both online and offline. The app is available free of charge from the Apple® iTunes® Store (iOS) as well as the Google Play store (Android).

Mobile internet. The whole world of Mercedes-Benz can be explored at any time with your web-capable mobile device – including specially adapted content for both smartphones and tablets. As well as an overview of all the passenger car models, there are insights into the entire brand world along with a wealth of entertainment offers and direct links to our range of services at www.mercedes-benz.com

Mercedes-Benz service contracts. You need never worry about unexpected workshop costs⁴ again: depending on the specific contract, a Mercedes-Benz service contract can cover unforeseen repairs, maintenance or wear parts. As a result, your vehicle stays in great condition – thanks to the Mercedes-Benz quality you can expect from our highly qualified workshop specialists and Mercedes-Benz genuine parts. Your Mercedes-Benz dealer will be pleased to tell you more about the available service contracts and terms and conditions.



Accident repairs. Should the worst happen and you find yourself in need of repairs, with the Mercedes-Benz accident repair service you will receive the right assistance for your vehicle and ensure that its high-quality safety features are properly maintained. Whether you need paint, body or glass repair work carried out, the highly trained specialists at your Mercedes-Benz service partner will repair your Mercedes-Benz and get you quickly back on the road again. Further information is available from your authorised Mercedes-Benz dealer.



⁴ In accordance with the terms and conditions of the Mercedes-Benz service contracts.

Dimensions for saloon.

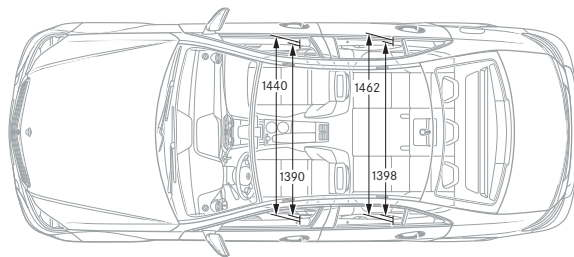
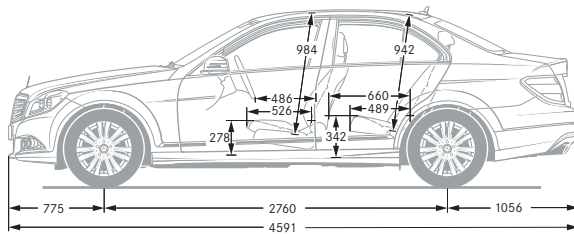
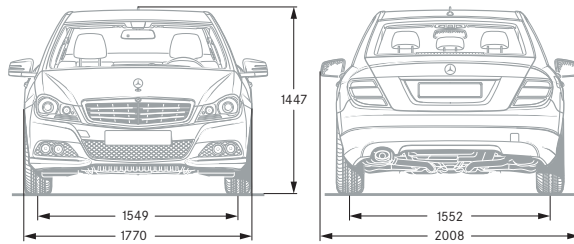

Dimensions for estate.

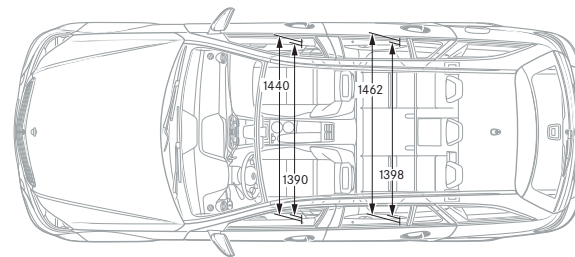
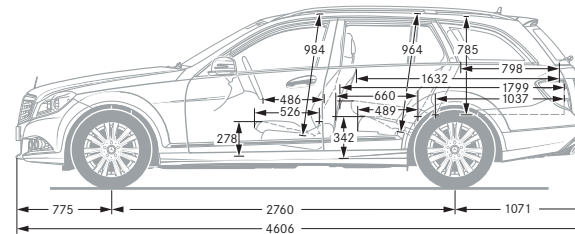
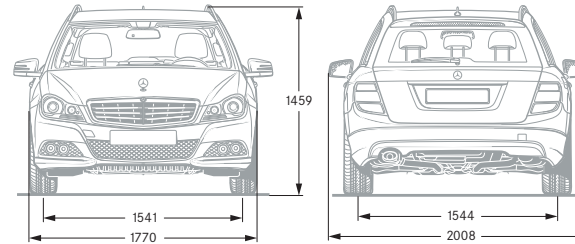

Paintwork.

The paint system developed by Mercedes-Benz includes one of the best clearcoats on the automotive market and is a key factor behind the car's value retention. The secret lies in the exceptionally dense molecular structure, which makes both the metallic and the non-metallic clearcoats more resistant and produces a longer-lasting and visibly more intensive shine.

Non-metallic paints (standard)

- 040 black
- 149 polar white
- 590 fire opal

Metallic paints (option)

- 183 magnetite black
- 197 obsidian black
- 526 dolomite brown
- 755 tenorite grey
- 775 iridium silver
- 792 palladium silver
- 890 cavansite blue
- 988 diamond silver

Special paint (option)

- 799 diamond white metallic BRIGHT

Technical data for saloon.

	C 180 CDI	C 200 CDI	C 220 CDI	C 220 CDI 4MATIC	C 220 CDI BE Edition	C 250 CDI	C 250 CDI 4MATIC	C 300 CDI 4MATIC	C 350 CDI
Diesel engines									
Total displacement in cc	2143	2143	2143	2143	2143	2143	2143	2987	2987
Rated output ¹ in kW (hp) at rpm	88 (120)/2800-4600 [88 (120)/3000-4600]	100 (136)/ 2800-4600	125 (170)/ 3000-4200	125 (170)/ 3000-4200	125 (170)/ 3000-4200	150 (204)/ 4200	150 (204)/ 4200	170 (231)/ 3800	195 (265)/ 3800
Accel. 0-100 km/h in s	10.5	9.2 [9.1]	8.4 [8.1]	- [8.2]	8.4 [8.1]	7.0 [7.1]	- [7.1]	- [6.4]	- [6.0]
Top speed, approx. in km/h	208 [206]	218 [215]	232 [231]	- [227]	232 [231]	240 [240]	- [240]	- [250] ³	- [250] ³
Fuel consumption ² in l/100 km									
Urban	6.3-5.9 [6.4-6.1]	6.3-5.9 [6.4-6.1]	6.3-5.6 [6.4-6.0]	- [6.9-6.7]	5.2 [5.4]	6.7-6.1 [6.4-6.0]	- [6.9-6.7]	- [9.2-9.1]	- [7.2]
Extra-urban	4.7-4.1 [4.7-4.3]	4.7-4.1 [4.7-4.3]	4.3-3.7 [4.5-4.1]	- [5.0-4.6]	3.5 [3.8]	4.5-4.0 [4.5-4.1]	- [5.0-4.6]	- [6.1-5.9]	- [5.3-5.2]
Combined	5.3-4.8 [5.3-4.9]	5.3-4.8 [5.3-4.9]	5.1-4.4 [5.2-4.8]	- [5.7-5.4]	4.1 [4.4]	5.3-4.8 [5.2-4.8]	- [5.7-5.4]	- [7.2-7.0]	- [6.0-5.9]
CO ₂ emissions ² in g/km comb.	139-125 [140-129]	139-125 [140-129]	133-117 [136-125]	- [152-144]	109 [116]	140-125 [136-125]	- [152-144]	- [189-185]	- [157-154]
Efficiency class	A [A]	A [A]	A [A]	- [B]	A+ [A]	A [A]	- [B]	- [D]	- [C]
Emission class	Euro 5	Euro 5	Euro 5	Euro 5	Euro 5	Euro 5	Euro 5	Euro 5	Euro 5
Petrol engines									
	C 180	C 200	C 250	C 350	C 350 4MATIC	C 63 AMG			
						w/o Performance package	with Performance package		
Total displacement in cc	1595	1796	1796	3498	3498	6208	6208		
Rated output ¹ in kW (hp) at rpm	115 (156)/5300	135 (184)/5250	150 (204)/5500	225 (306)/6500	225 (306)/6500	336 (457)/6800	358 (487)/6800		
Accel. 0-100 km/h in s	8.5	8.2 [7.8]	- [7.2]	- [6.0]	- [6.0]	- [4.4]	- [4.3]		
Top speed, approx. in km/h	225 [223]	237 [235]	- [240]	- [250] ³	- [250] ³	- [250] ³	- [250] ³		
Fuel consumption ² in l/100 km									
Urban	8.1-7.7 [8.0-7.7]	9.8-9.3 [9.0-8.7]	- [9.0-8.7]	- [9.6-9.4]	- [10.1-10.0]	- [18.2]	- [18.2]		
Extra-urban	5.4-4.7 [5.3-4.8]	5.8-5.2 [5.6-5.1]	- [5.6-5.1]	- [5.6-5.3]	- [6.1-5.9]	- [8.4]	- [8.4]		
Combined	6.4-5.8 [6.3-5.8]	7.2-6.6 [6.9-6.4]	- [6.9-6.4]	- [7.0-6.8]	- [7.6-7.4]	- [12.0]	- [12.0]		
CO ₂ emissions ² in g/km comb.	149-136 [147-136]	168-154 [161-150]	- [161-150]	- [164-159]	- [178-174]	- [280]	- [280]		
Efficiency class	B [B]	C [C]	- [C]	- [C]	- [D]	- [G]	- [G]		
Emission class	Euro 6	Euro 5	Euro 5	Euro 5	Euro 5	Euro 5	Euro 5		

¹ Figures in accordance with Directive 80/1269/EEC in the currently applicable version. ² The figures shown were obtained in accordance with the prescribed measuring process (Directive [EC] 715/2007 in the currently applicable version).

The figures are not based on an individual vehicle and do not constitute part of the product offer; they are provided solely for the purposes of comparison between different vehicle models. ³ Electronically limited.

Figures in square brackets apply to vehicles with automatic transmission. You can find further technical data at www.mercedes-benz.com

Technical data for estate.

	C 180 CDI	C 200 CDI	C 220 CDI	C 220 CDI 4MATIC	C 220 CDI BE Edition	C 250 CDI	C 250 CDI 4MATIC	C 300 CDI 4MATIC	C 350 CDI
Diesel engines									
Total displacement in cc	2143	2143	2143	2143	2143	2143	2143	2987	2987
Rated output ¹ in kW (hp) at rpm	88 (120)/2800-4600 [88 (120)/3000-4600]	100 (136)/ 2800-4600	125 (170)/ 3000-4200	125 (170)/ 3000-4200	125 (170)/ 3000-4200	150 (204)/ 4200	150 (204)/ 4200	170 (231)/ 3800	195 (265)/ 3800
Accel. 0-100 km/h in s	10.8	9.6 [9.5]	8.5 [8.3]	- [8.4]	8.5	7.3 [7.4]	- [7.4]	- [6.5]	- [6.3]
Top speed, approx. in km/h	201 [200]	209 [207]	219 [219]	- [219]	219	238 [237]	- [235]	- [242]	- [250] ³
Fuel consumption ² in l/100 km									
Urban	6.4-6.0 [6.5-6.2]	6.4-6.0 [6.5-6.2]	6.3-6.0 [6.4-6.3]	- [6.9-6.7]	5.3	6.7-6.3 [6.4-6.3]	- [6.9-6.7]	- [9.3-9.2]	- [7.4-7.3]
Extra-urban	4.8-4.1 [4.9-4.5]	4.8-4.1 [4.9-4.5]	4.5-4.0 [4.6-4.3]	- [5.1-4.8]	3.8	4.6-4.1 [4.6-4.3]	- [5.1-4.8]	- [6.4-6.0]	- [5.4]
Combined	5.4-4.8 [5.5-5.1]	5.4-4.8 [5.5-5.1]	5.2-4.7 [5.3-5.1]	- [5.8-5.5]	4.3	5.4-4.9 [5.3-5.1]	- [5.8-5.5]	- [7.4-7.2]	- [6.2-6.0]
CO ₂ emissions ² in g/km comb.	141-127 [144-134]	141-127 [144-134]	135-124 [138-134]	- [155-147]	114	141-128 [138-134]	- [155-147]	- [195-191]	- [162-159]
Efficiency class	A [B]	A [B]	A [A]	- [B]	A+	A [A]	- [B]	- [D]	- [C]
Emission class	Euro 5	Euro 5	Euro 5	Euro 5	Euro 5	Euro 5	Euro 5	Euro 5	Euro 5
Petrol engines									
	C 180	C 200	C 250	C 350	C 63 AMG				
					w/o Performance package	with Performance package			
Total displacement in cc	1595	1796	1796	3498	6208	6208			
Rated output ¹ in kW (hp) at rpm	115 (156)/5300	135 (184)/5250	150 (204)/5500	225 (306)/6500	336 (457)/6800	358 (487)/6800			
Accel. 0-100 km/h in s	8.7	8.4 [8.1]	- [7.4]	- [6.1]	- [4.5]	- [4.4]			
Top speed, approx. in km/h	218 [216]	228 [226]	- [233]	- [250] ³	- [250] ³	- [250] ³			
Fuel consumption ² in l/100 km									
Urban	8.0-7.7 [7.9-7.6]	10.2-9.6 [9.1-8.9]	- [9.1-8.9]	- [9.9-9.7]	- [18.6]	- [18.6]			
Extra-urban	5.5-4.9 [5.5-4.9]	6.2-5.5 [5.7-5.4]	- [5.7-5.4]	- [5.8-5.6]	- [8.5]	- [8.5]			
Combined	6.4-5.9 [6.4-5.9]	7.6-6.9 [6.9-6.7]	- [6.9-6.7]	- [7.3-7.1]	- [12.2]	- [12.2]			
CO ₂ emissions ² in g/km comb.	150-139 [149-139]	177-160 [162-155]	- [162-155]	- [170-165]	- [285]	- [285]			
Efficiency class	B [B]	D [C]	- [C]	- [C]	- [G]	- [G]			
Emission class	Euro 6	Euro 5	Euro 5	Euro 5	Euro 5	Euro 5			

¹ Figures in accordance with Directive 80/1269/EEC in the currently applicable version. ² The figures shown were obtained in accordance with the prescribed measuring process (Directive [EC] 715/2007 in the currently applicable version). The figures are not based on an individual vehicle and do not constitute part of the product offer; they are provided solely for the purposes of comparison between different vehicle models. ³ Electronically limited. Figures in square brackets apply to vehicles with automatic transmission. You can find further technical data at www.mercedes-benz.com

Non-metallic paints

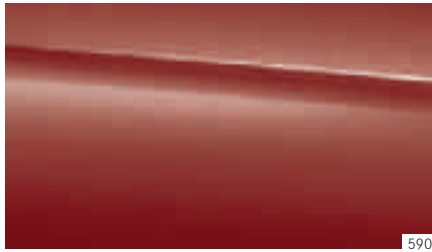
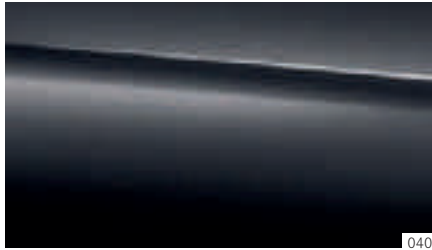

Metallic paints

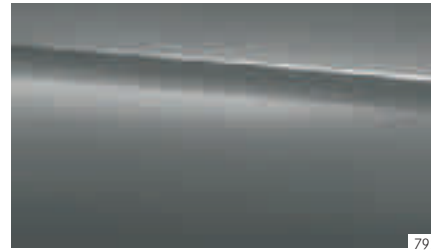
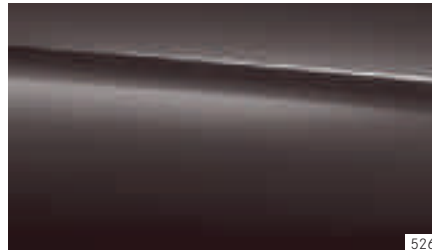
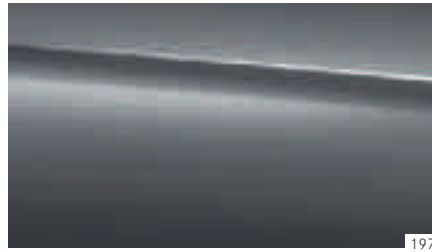

Special paint



Take-back of end-of-life vehicles. You can return your C-Class to us for environment-friendly disposal in accordance with the European Union (EU) End-Of-Life Vehicle Directive. But that day lies a long way off.

A network of vehicle take-back depots and dismantlers has been established to make it as easy as possible for you to return your vehicle. You can leave it at any of these points free of charge and, by doing so, make an important contribution to completing the recycling process and conserving resources.

For further information about the recycling and disposal of end-of-life vehicles, and the take-back conditions, please visit the national Mercedes-Benz website.

Please note: changes may have been made to the product since this brochure went to press (19.02.2013). The manufacturer reserves the right to make changes to the design, form, colour and specification during the delivery period, provided these changes, while taking into account the interests of the vendor, can be deemed reasonable with respect to the purchaser. Where the vendor or the manufacturer uses symbols or numbers to describe an order or the subject of an order, no rights may be derived solely from these. The illustrations may show accessories and items of optional equipment which are not part of standard specification. Colours may differ slightly from those shown in the brochure, owing to the limitations of the printing process. This brochure is distributed internationally. It provides a general indication of the range of models, features, optional extras, colours and/or services available in various countries. Some of the models, features, optional extras, colours and/or services shown may not be available in your country or may only be available in a different specification. Additionally some models, features, optional extras, colours and/or services may only be available in combination with others. For current and more specific information in relation to the range of models, features, optional extras, colours and/or services available in your country, and their pricing, you should contact your nearest authorised Mercedes-Benz Passenger Car Dealer.

www.mercedes-benz.com